

Overview of Exclusive Scattering SRC Measurements

Andrew Denniston

MIT

January 30th, 2023



Inclusive Measurements

$$\frac{\sigma_A/A}{\sigma_d/2}$$

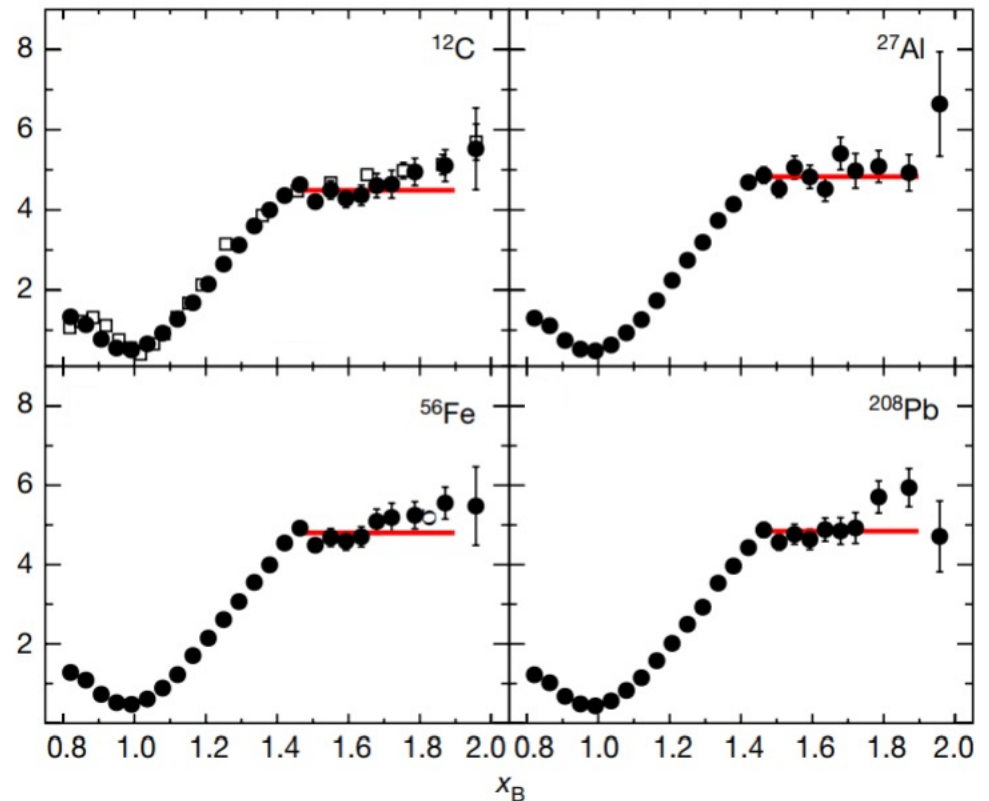
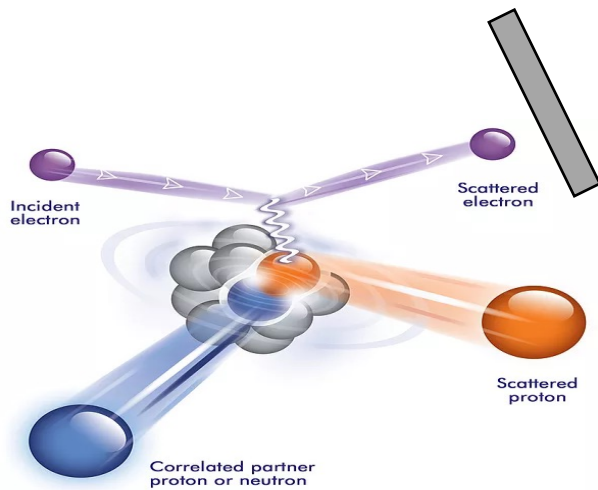

- Schmookler, Nature (2019)

$$x_B \equiv \frac{Q^2}{2m_N\omega} = \frac{q^2 - \omega^2}{2m_N\omega}$$

Inclusive Measurements

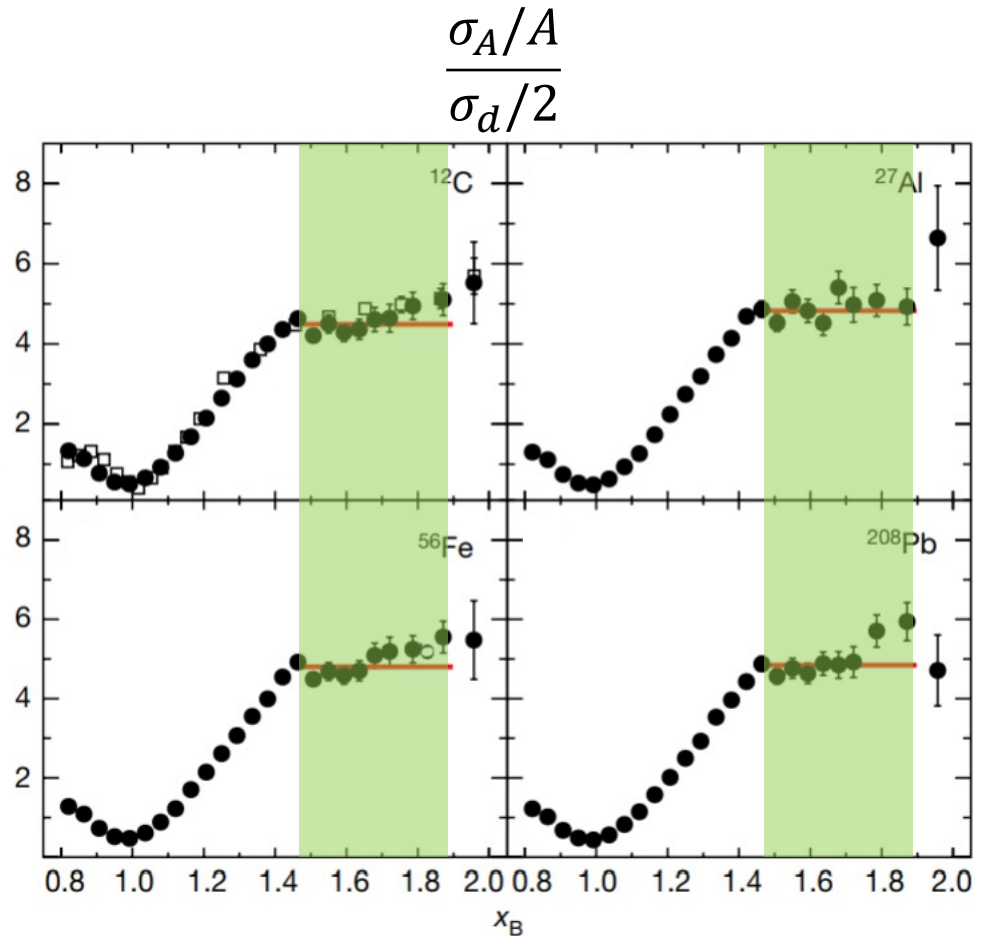
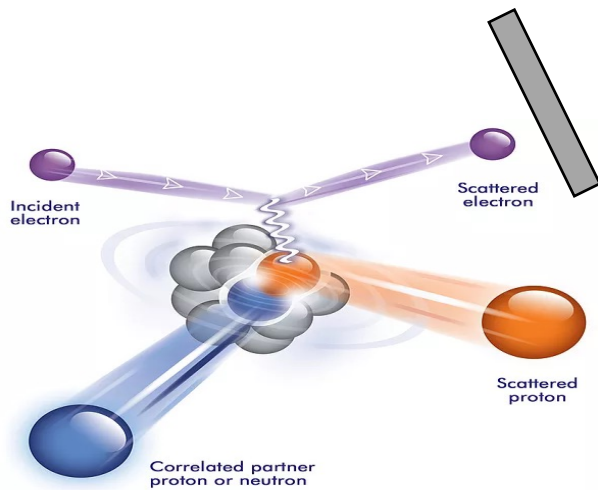

- Schmookler, Nature (2019)

$$x_B \equiv \frac{Q^2}{2m_N\omega} = \frac{q^2 - \omega^2}{2m_N\omega}$$

More Questions

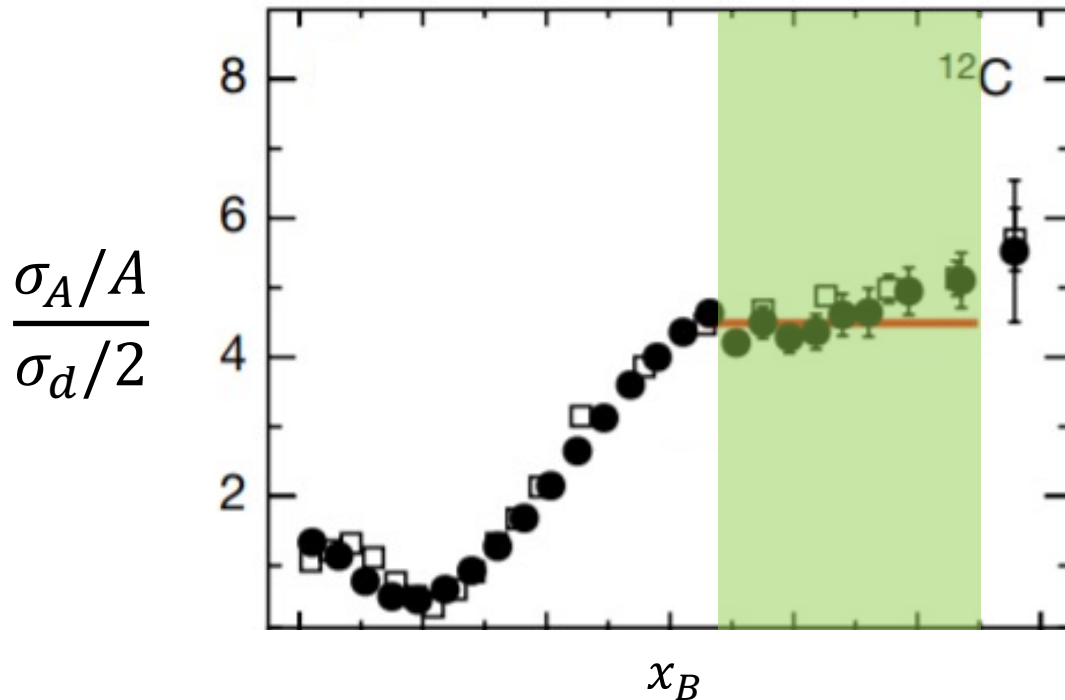

$$x_B \equiv \frac{Q^2}{2m_N\omega}$$

- How abundant are SRCs?
- What kinds of SRCs dominate?
- Do SRCs move in the nucleus?
- Can we learn anything about the NN interaction?

Tensor to Scalar with CLAS12

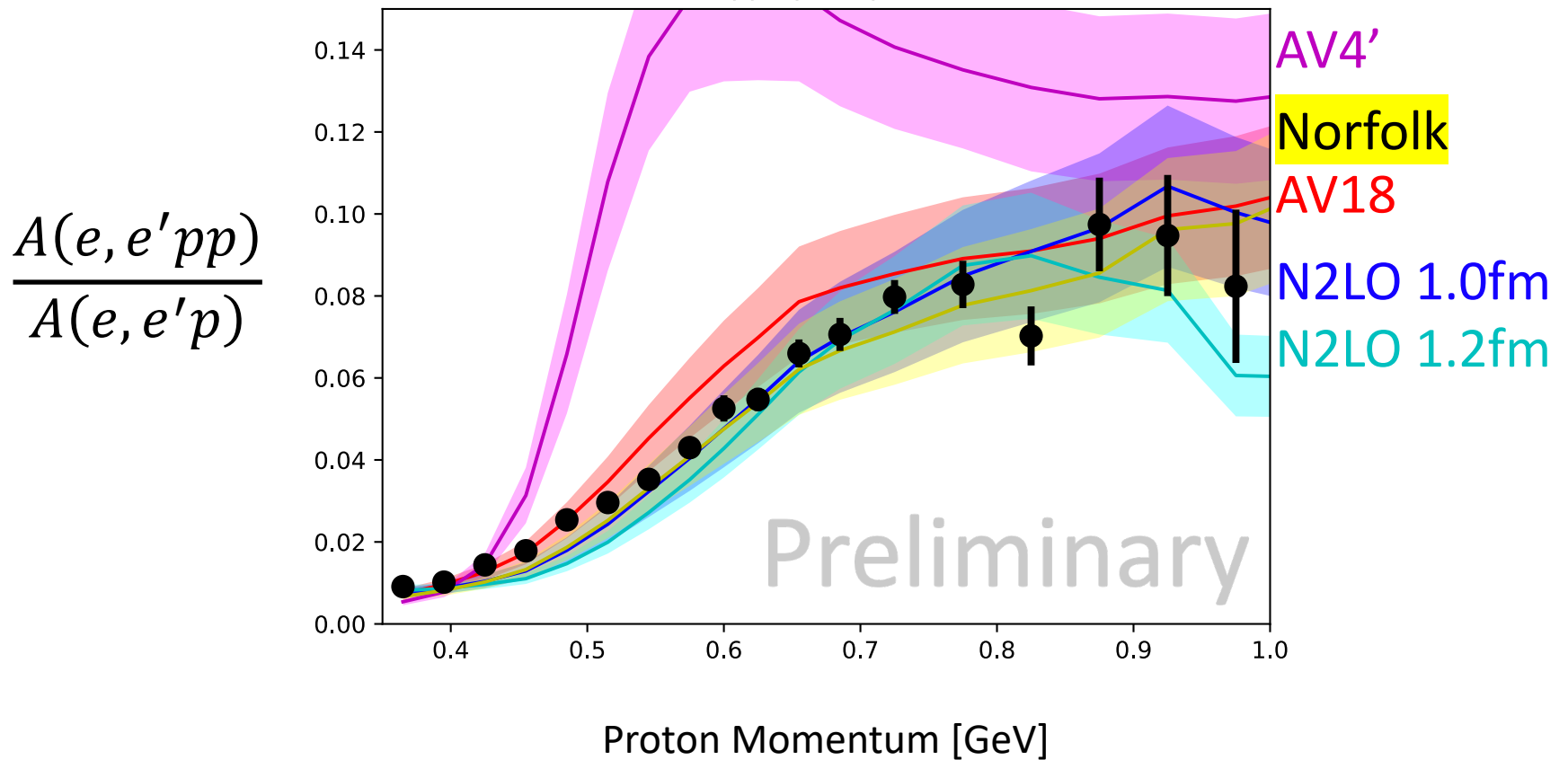

Inclusive Measurements

$$\frac{\sigma_A/A}{\sigma_d/2}$$

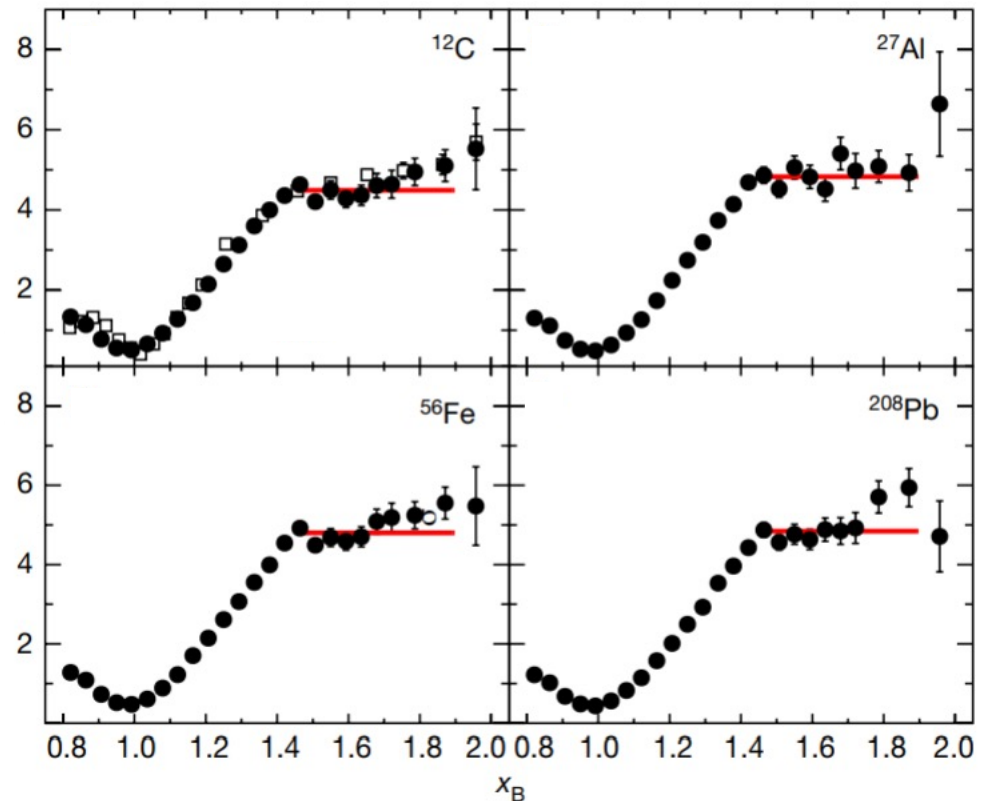
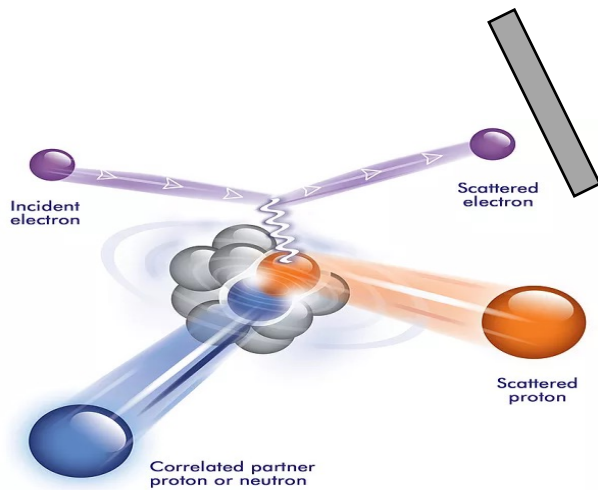

- Schmookler, Nature (2019)

$$x_B \equiv \frac{Q^2}{2m_N\omega} = \frac{q^2 - \omega^2}{2m_N\omega}$$

Exclusive Measurements

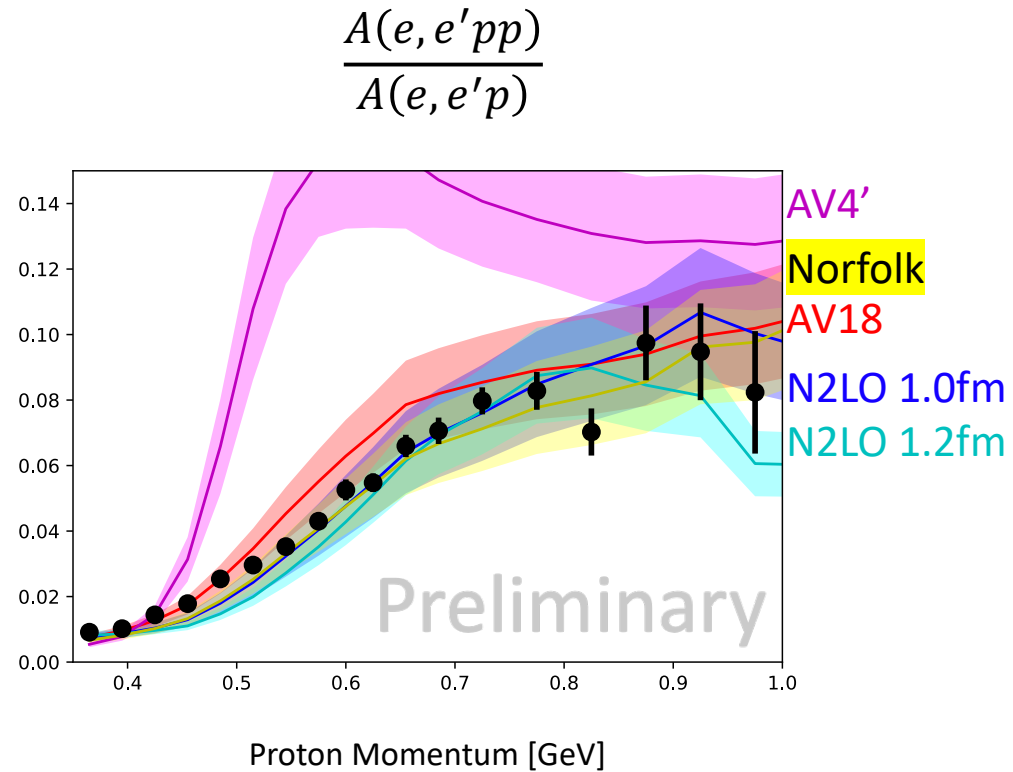
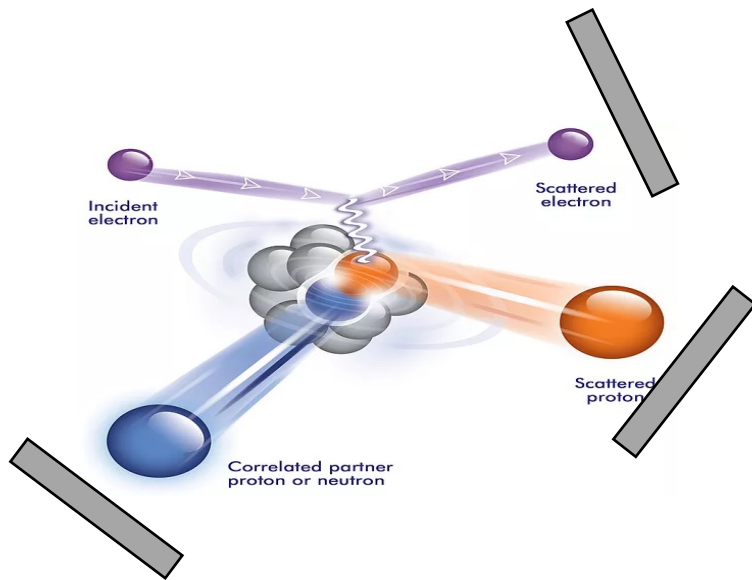

Overview of Exclusive SRC Measurements

- First Exclusive Measurements
- CLAS6: The Perfect Detector for SRCs
- Generalized Contact Formalism
- SRC Universality
- SRCs with CLAS12

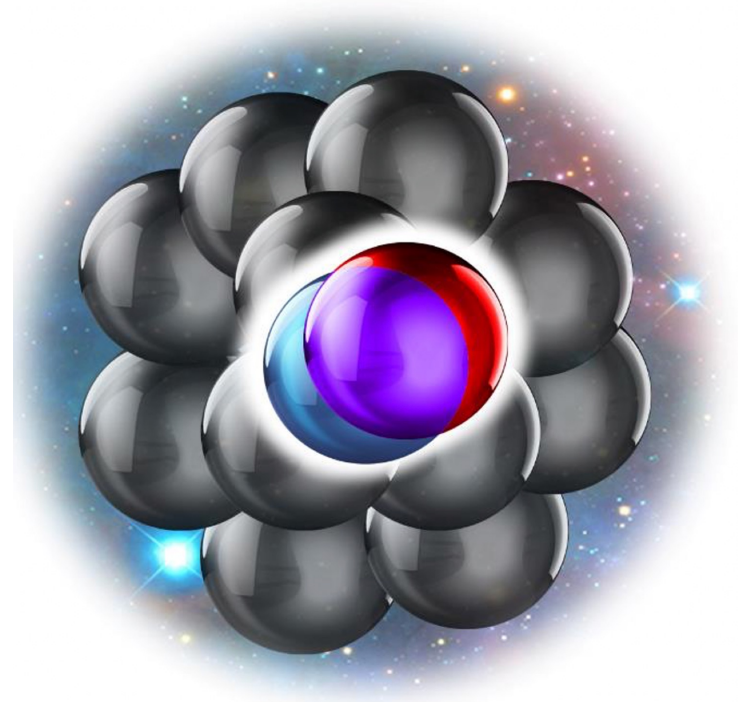

Overview of Exclusive SRC Measurements

- First Exclusive Measurements

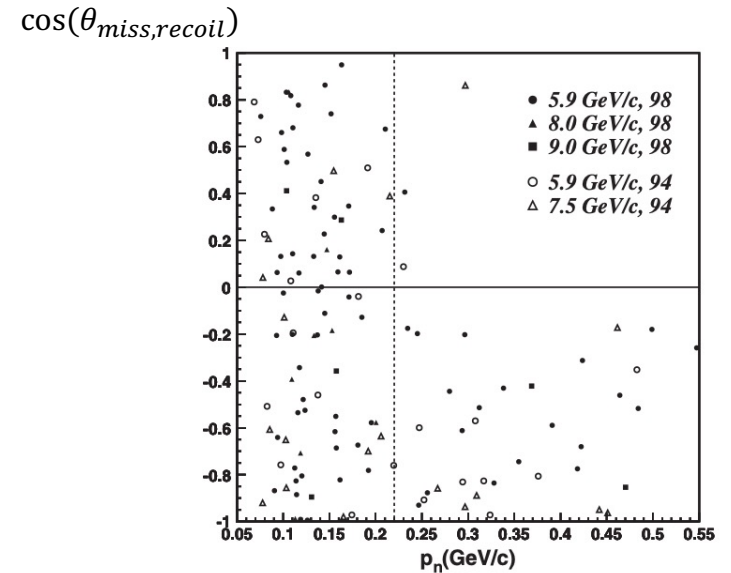

First Exclusive Measurements at Brookhaven

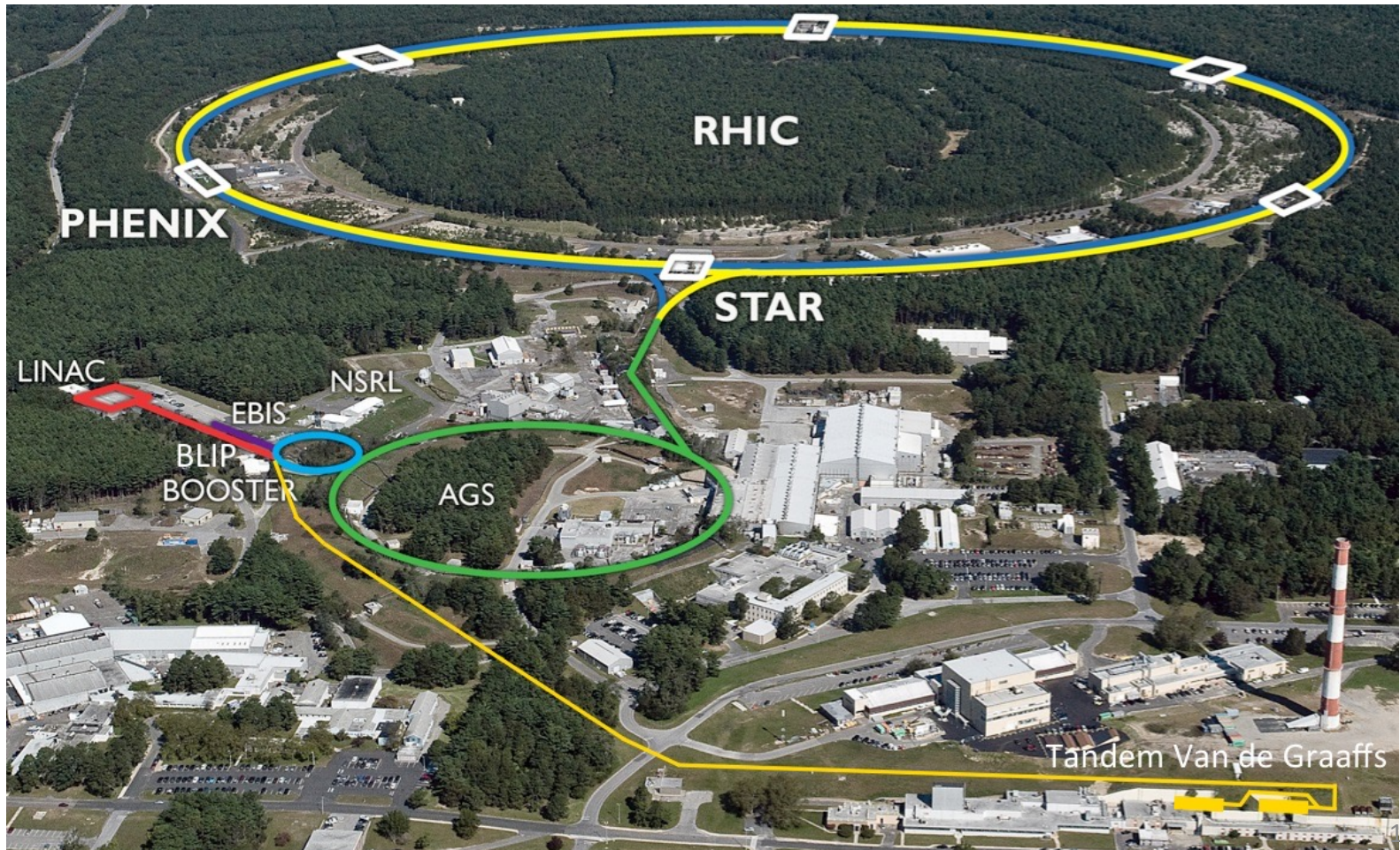

First Exclusive Measurements at Brookhaven

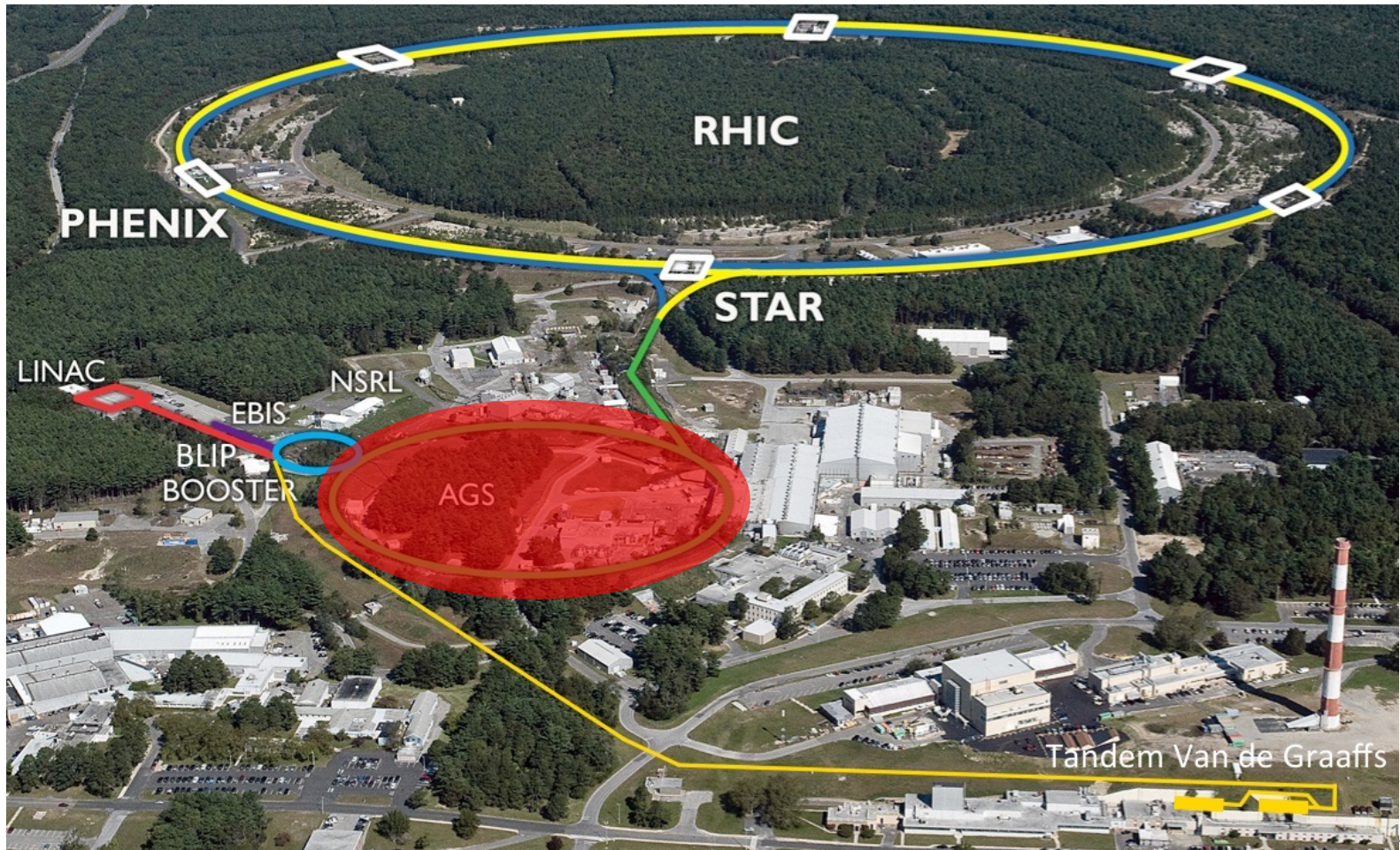

Triple Coincidence with the EVA Detector

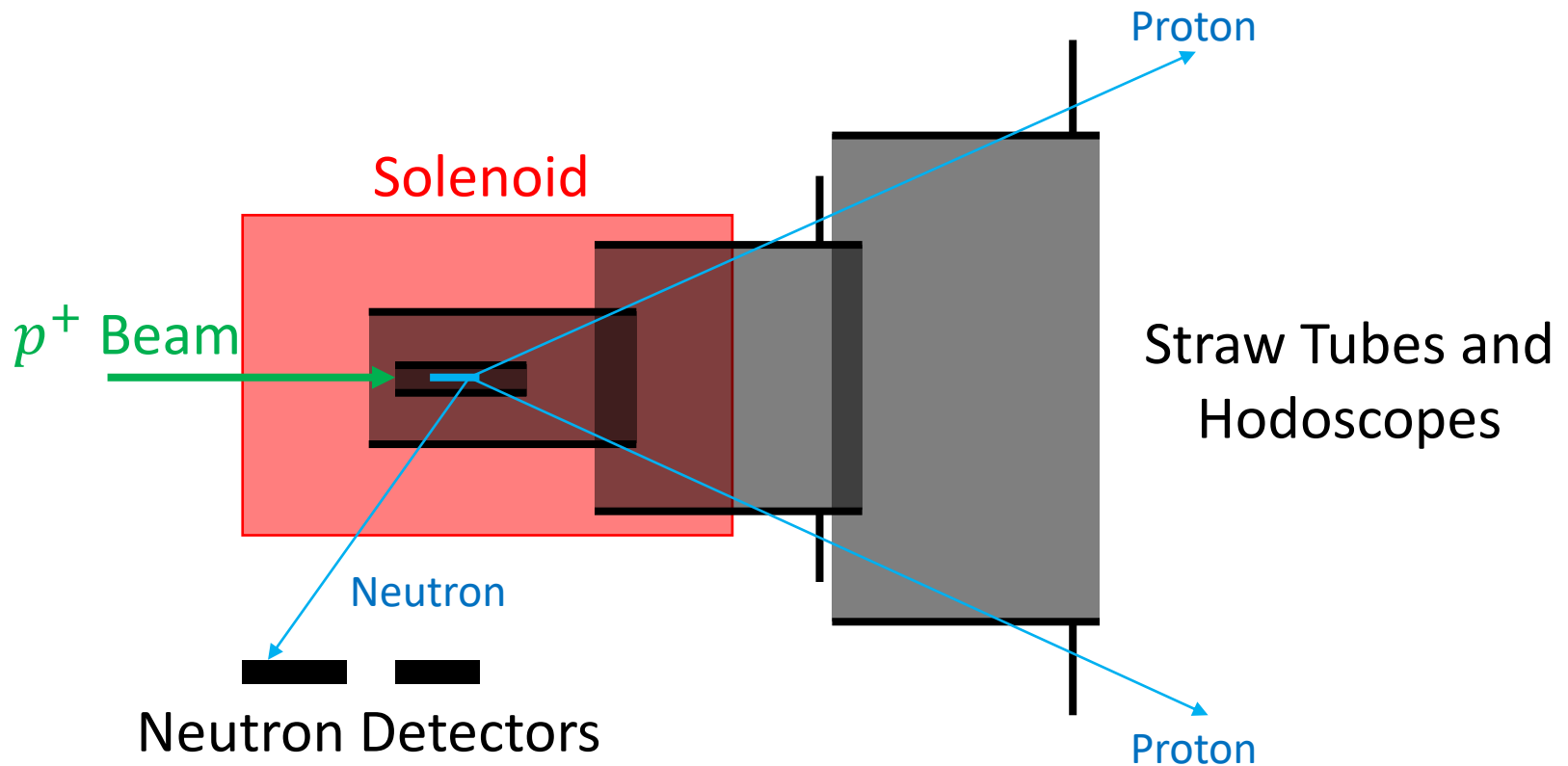

$$\mathbf{p}_{initial} = \mathbf{p}_1 + \mathbf{p}_2 - \mathbf{p}_{beam}$$

First Experimental Evidence of a Correlated Partner

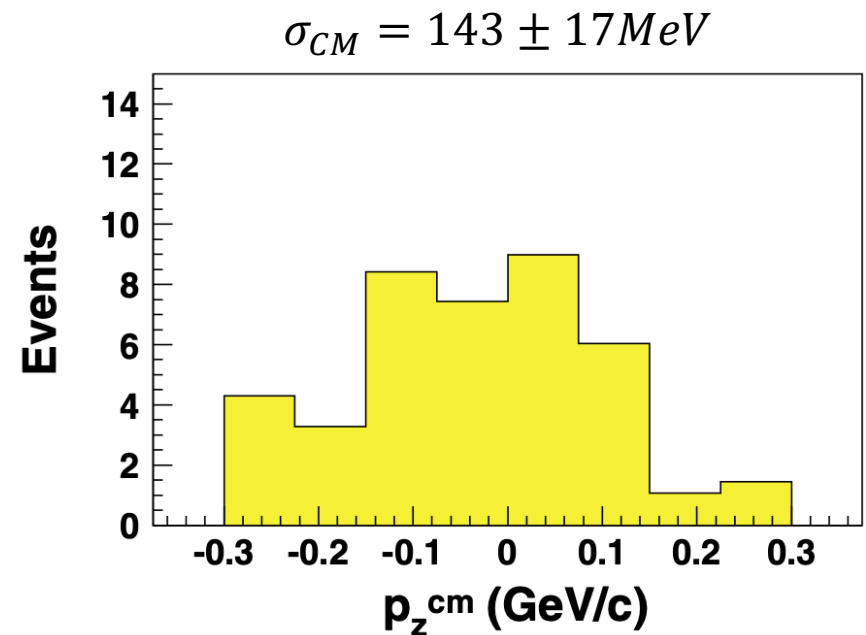
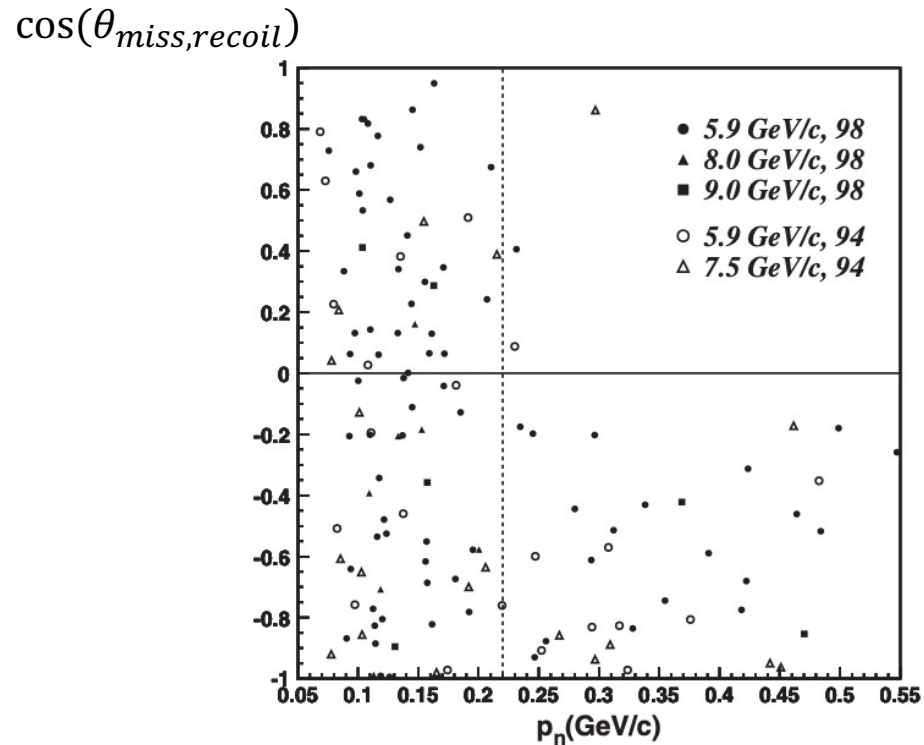

- Tang, PRL (2003)
- Piasezky, PRL (2006)

Evidence of np-dominance

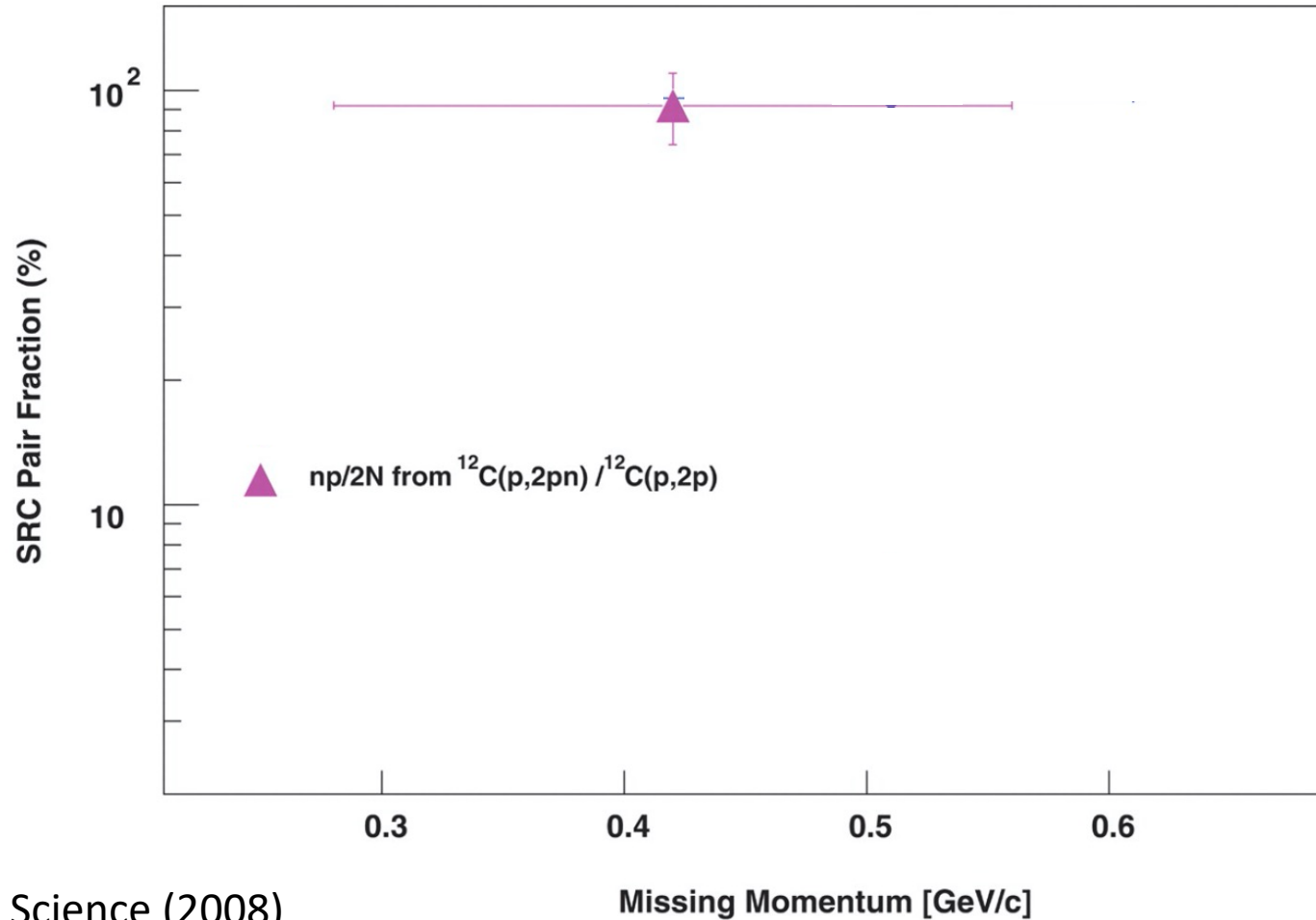

- Subedi, Science (2008)

Moving to Electron Probes



north linac

south linac

injector

Hall C

Hall B
CLAS

Hall A¹⁵

Hall-A Spectrometers

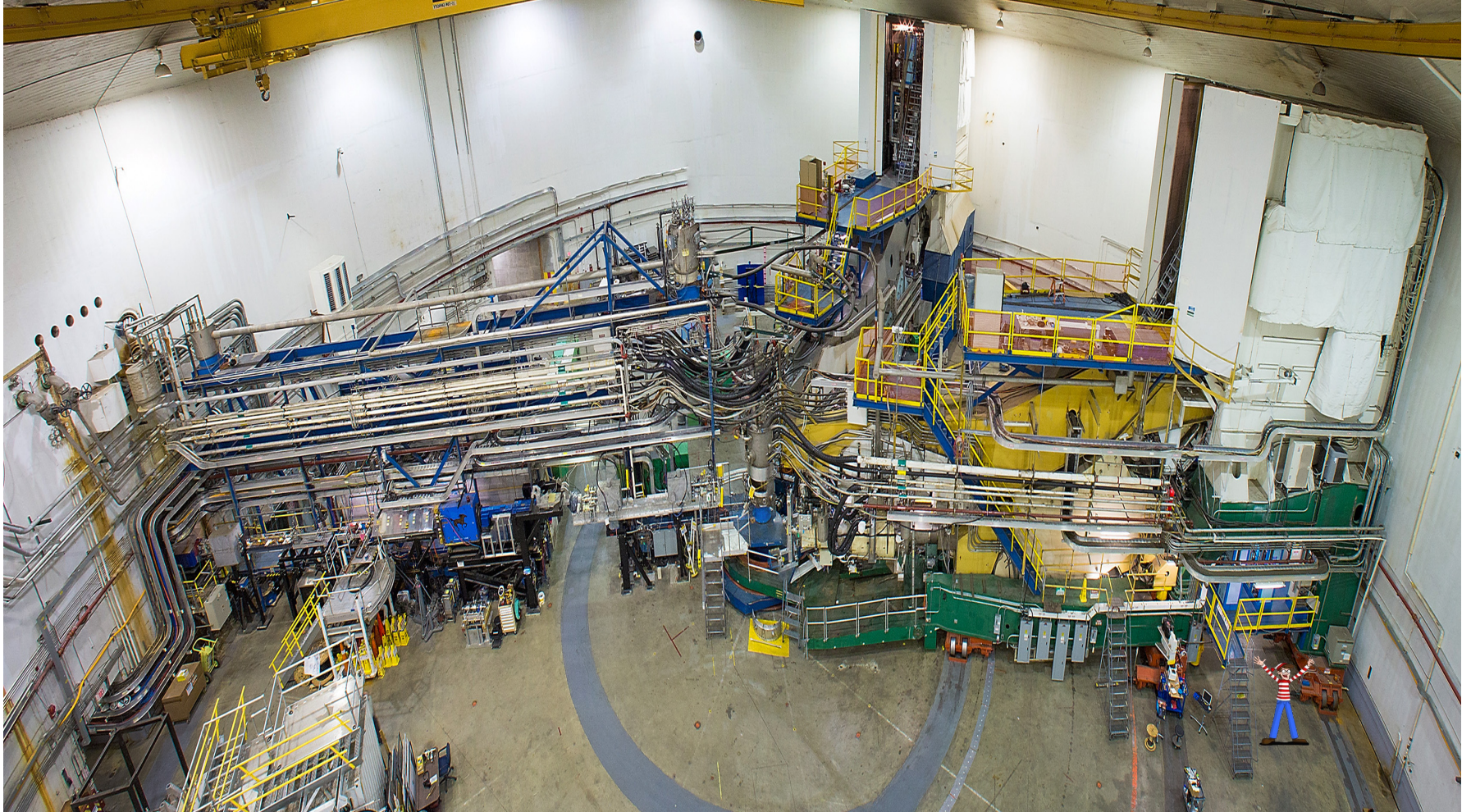

Hall-A Spectrometers

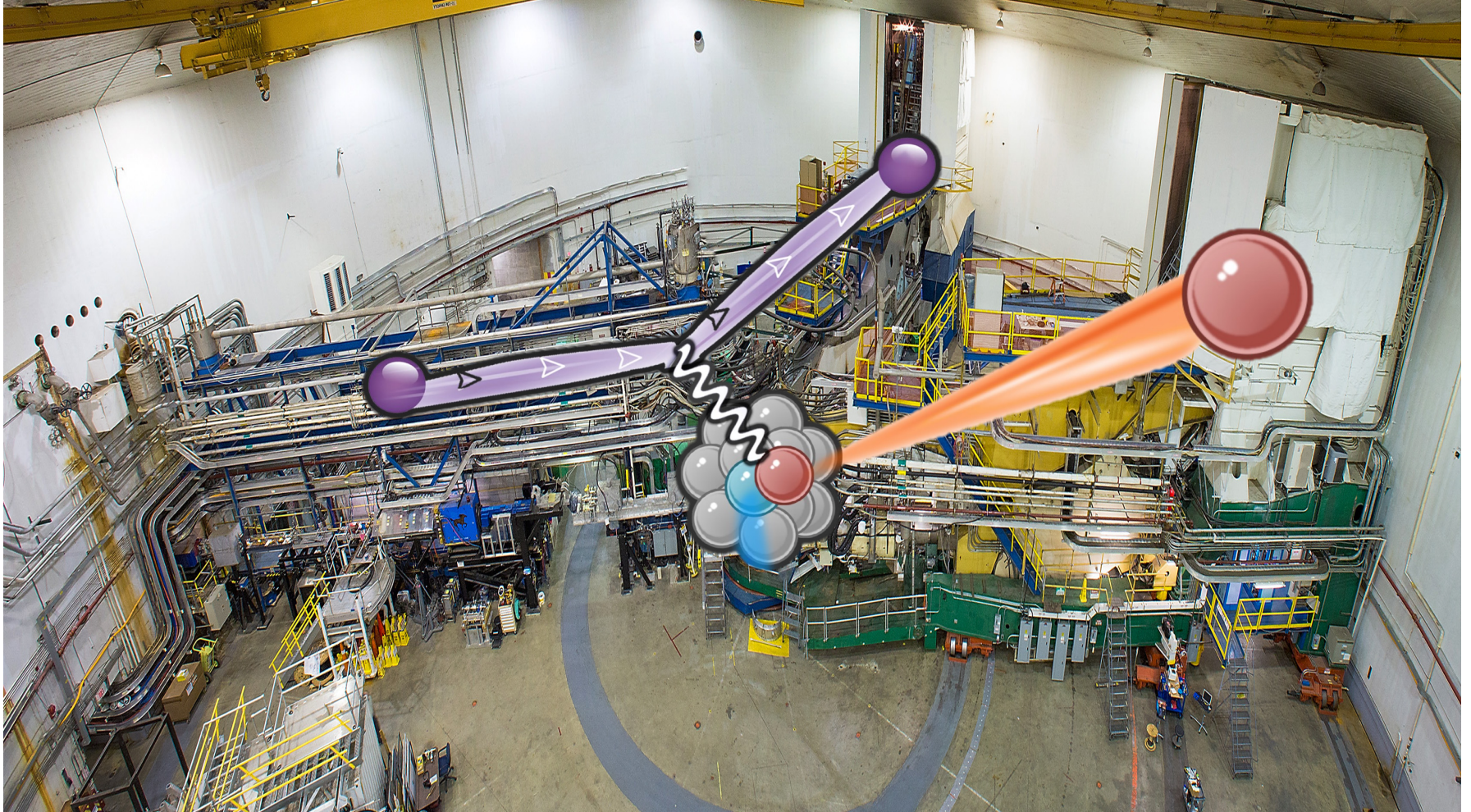

Hall-A Spectrometers

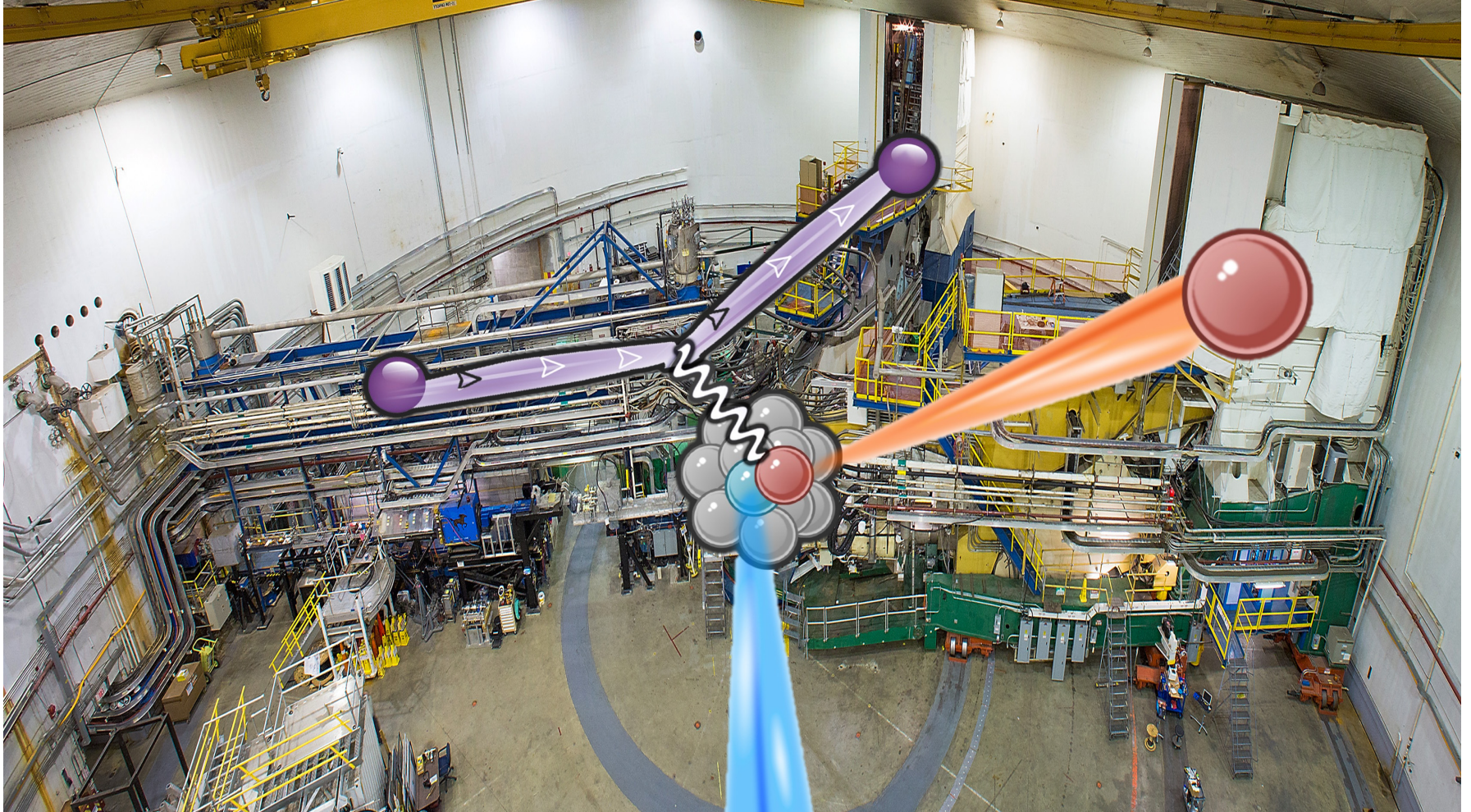

Hall-A Spectrometers

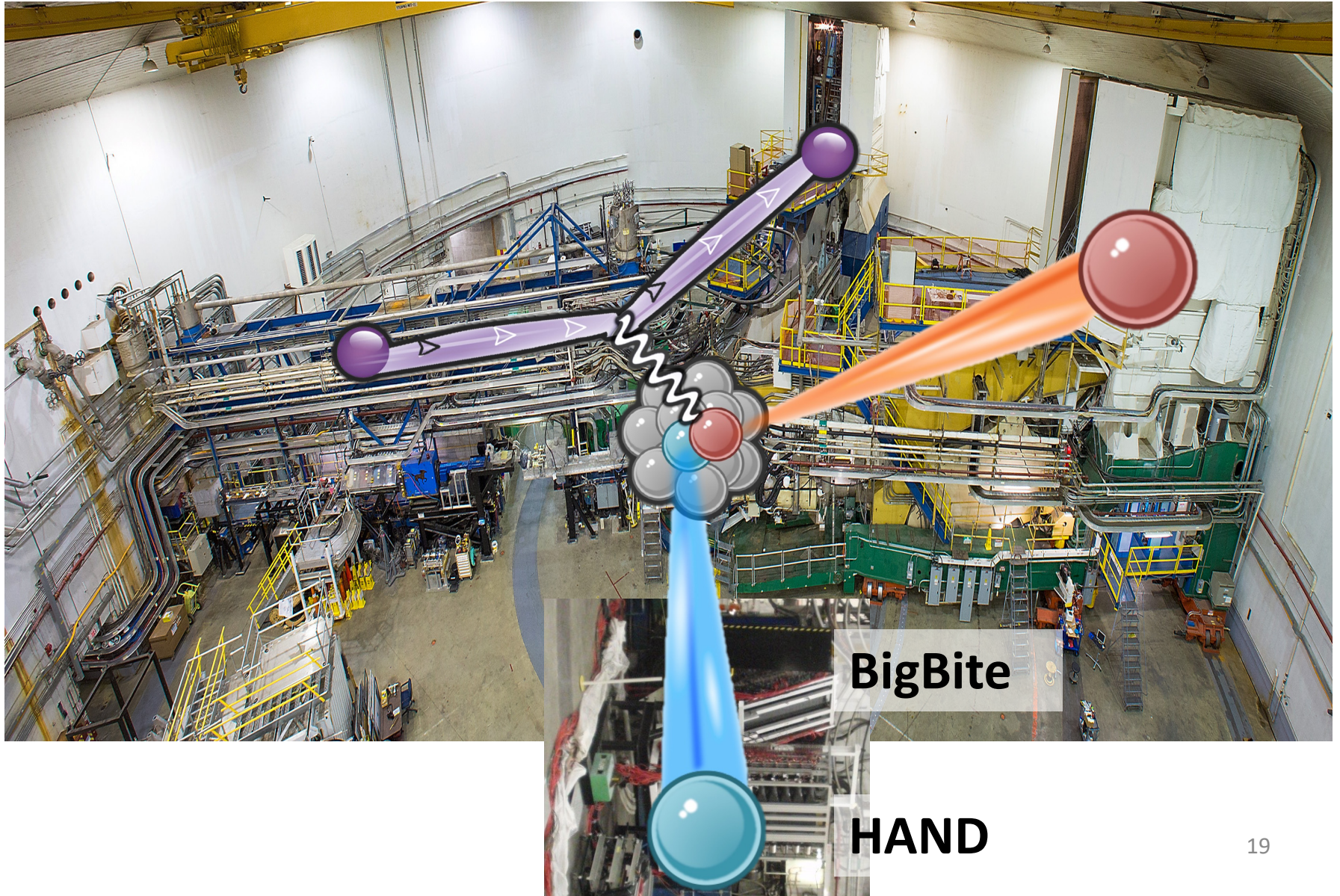

Triple Coincidence with High-Resolution Spectrometers

$$Q^2 = 2 \text{ GeV}^2$$

$$x_B = 1.2$$

$$p_{\text{miss}} = 350,450,550 \text{ MeV}/c$$

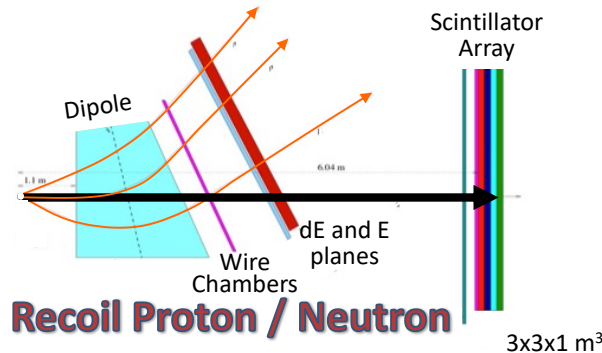
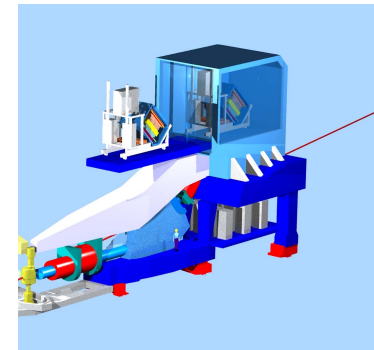
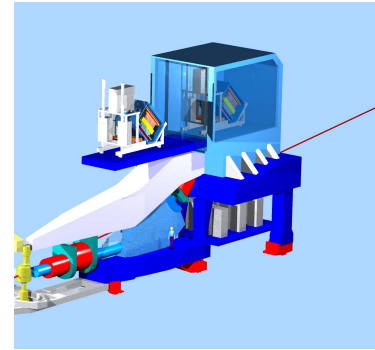
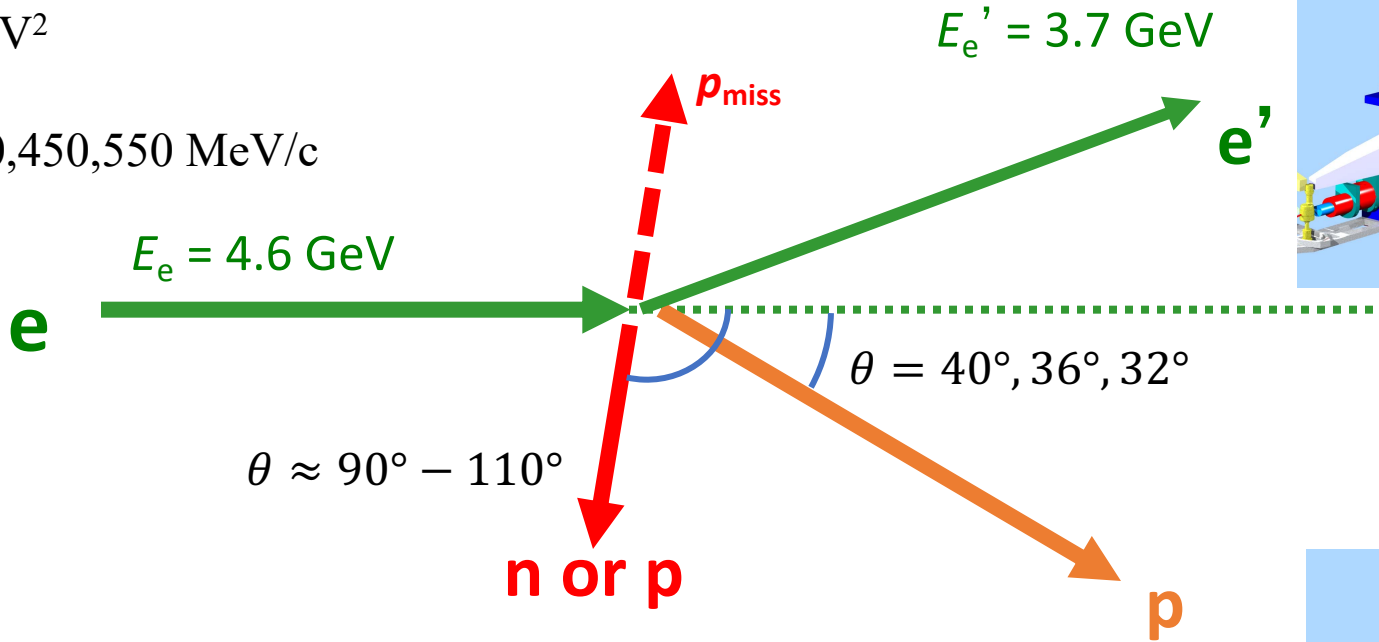

High Momentum Pairs are Back-to-Back

$$Q^2 = 2 \text{ GeV}^2$$

$$x_B = 1.2$$

$$p_{\text{miss}} = 350,450,550 \text{ MeV}/c$$

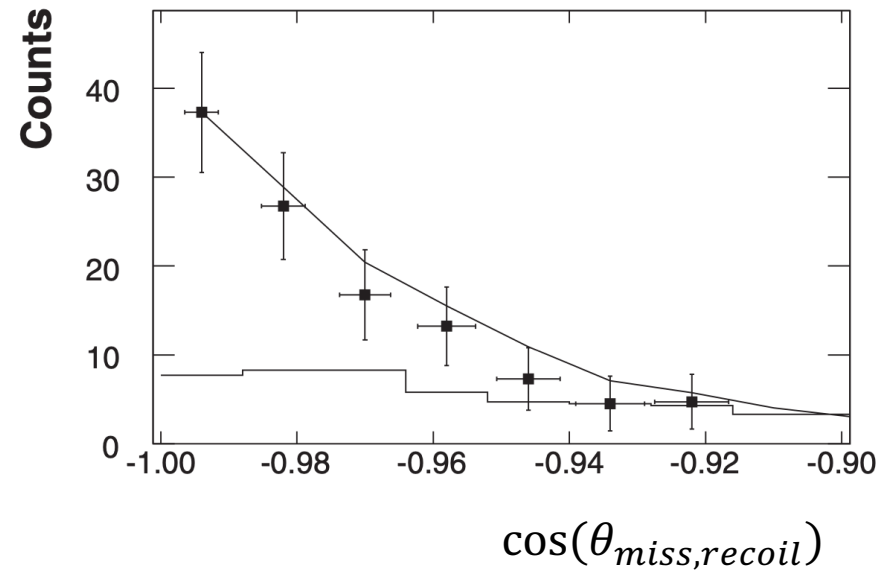
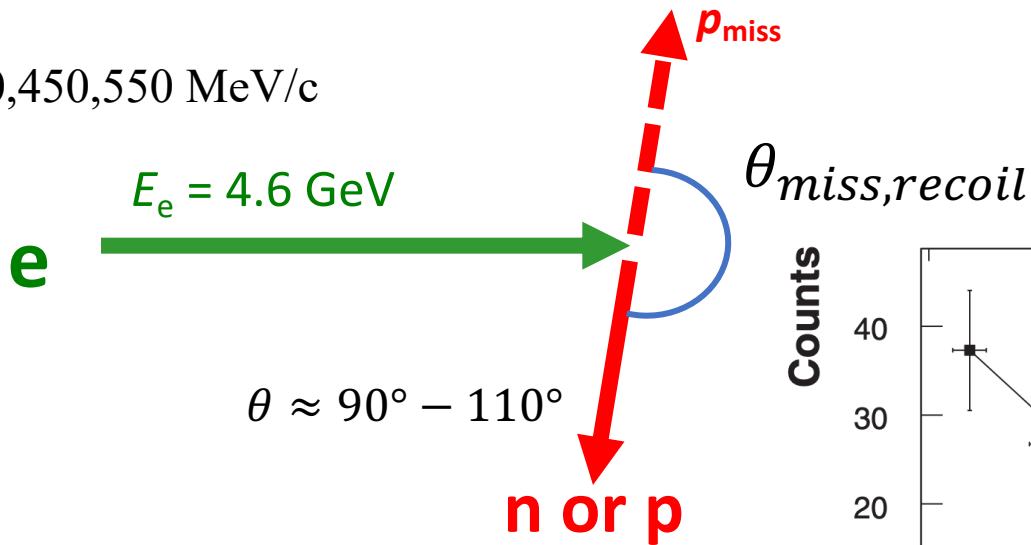

- Shneur, PRL (2007)

BNL Result

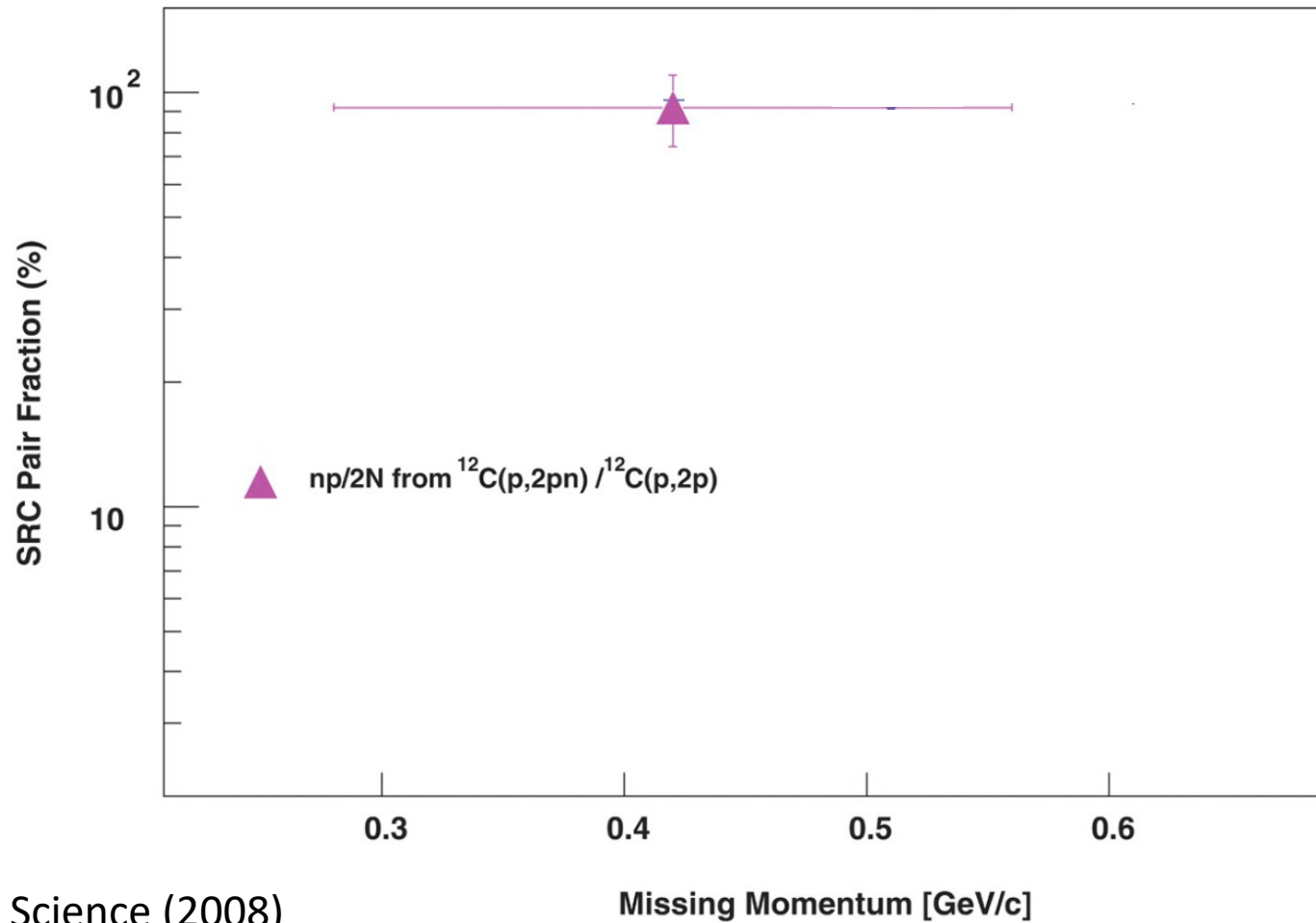

- Subedi, Science (2008)

Hall-A Further Supports np-Dominance

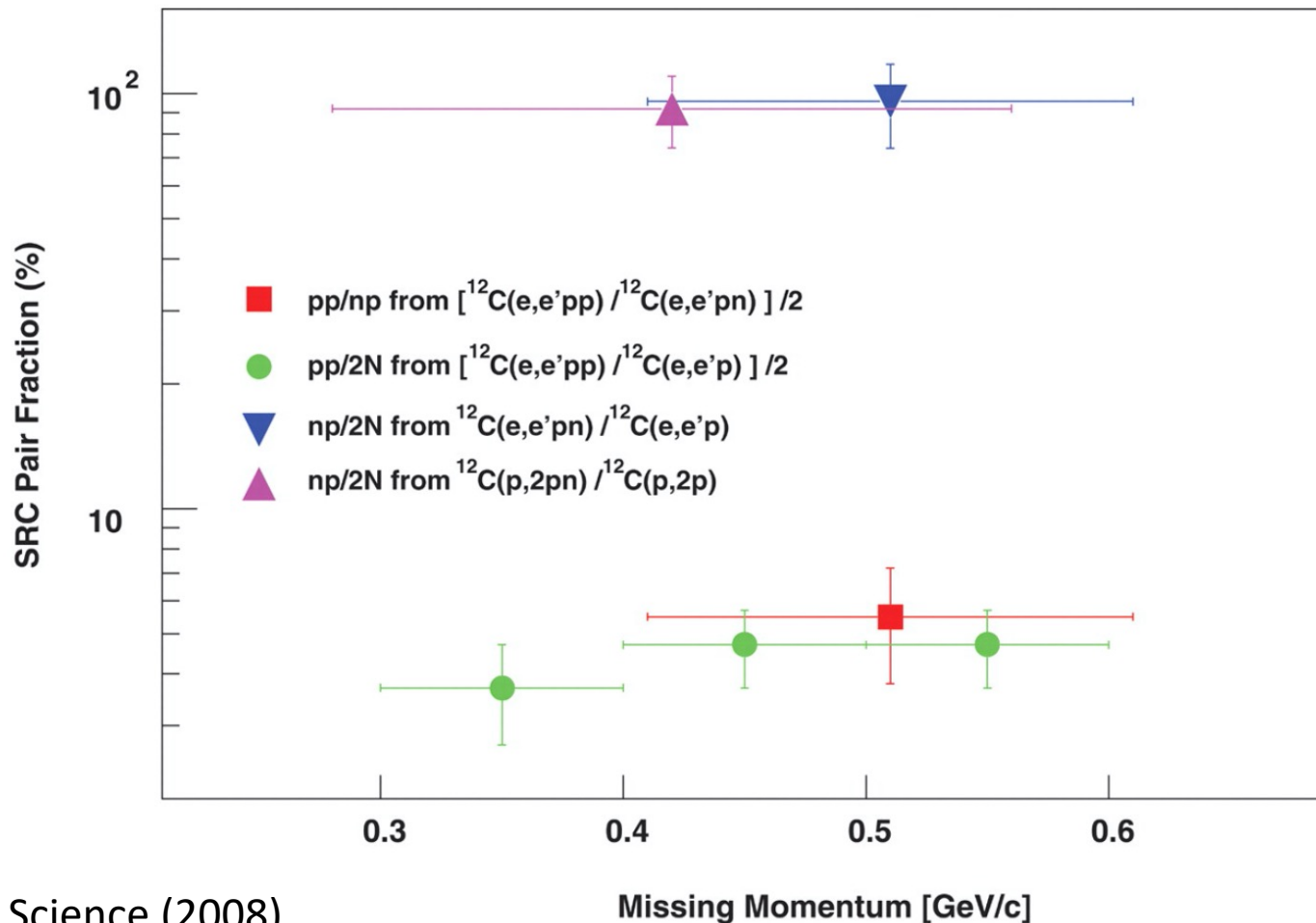

The Tensor Force

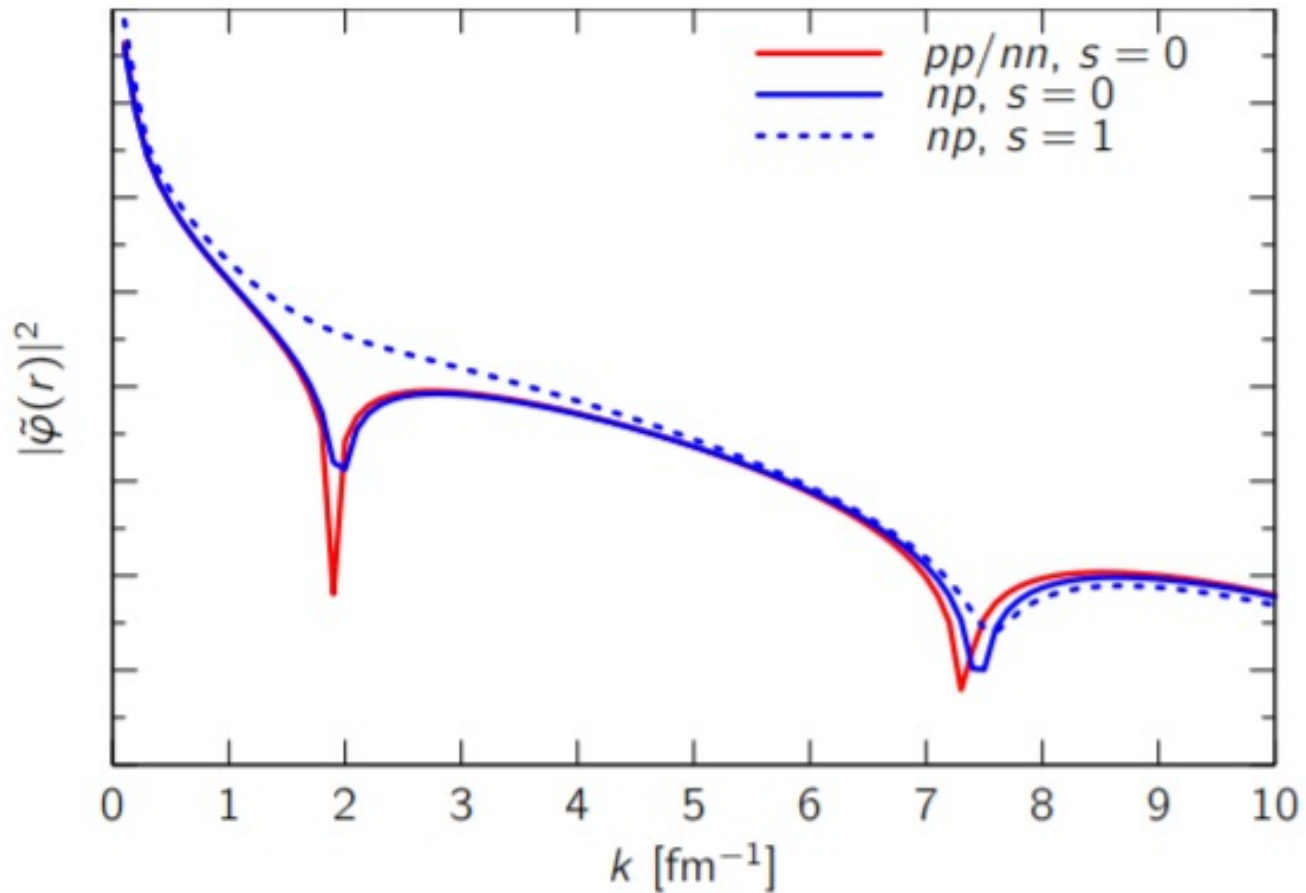

Isospin Configuration is Momentum Dependent

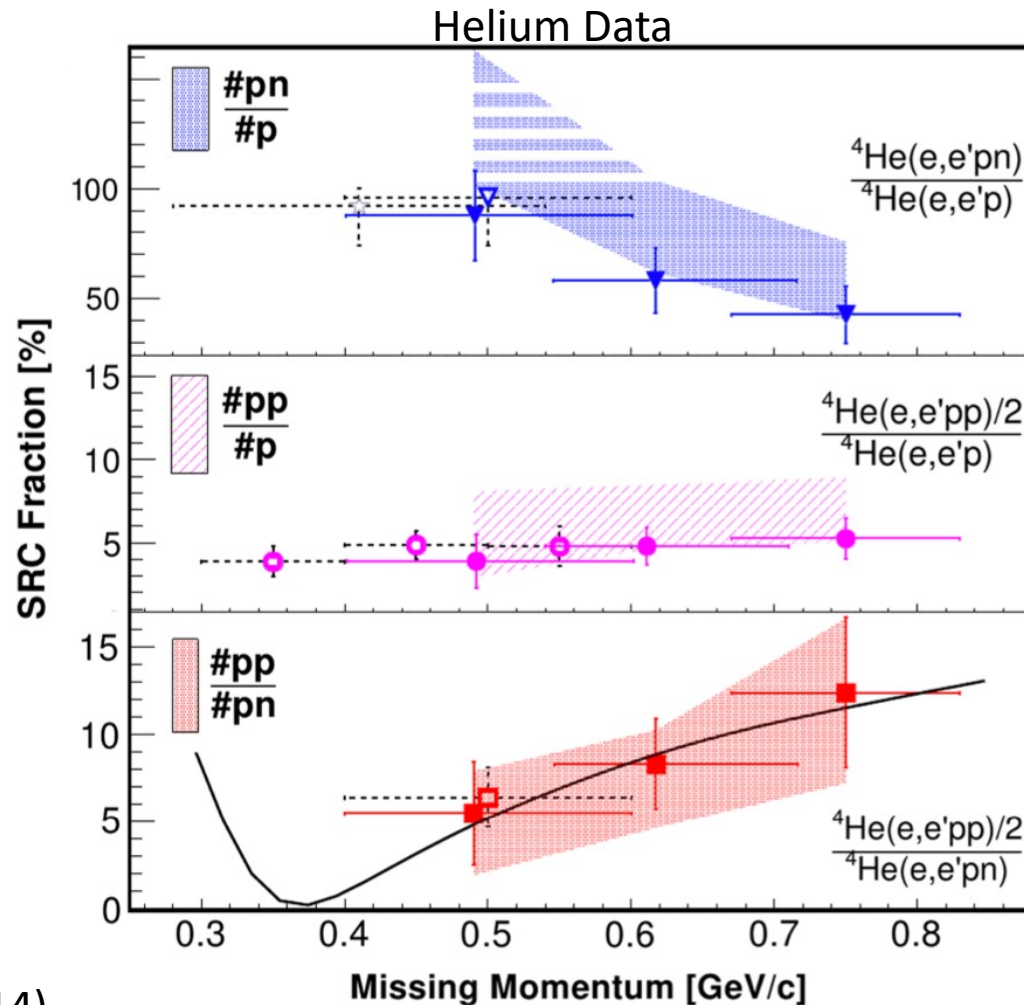

- Korover, PRL (2014)

Overview of Exclusive SRC Measurements

- First Exclusive Measurements
- CLAS6: The Perfect Detector for SRCs

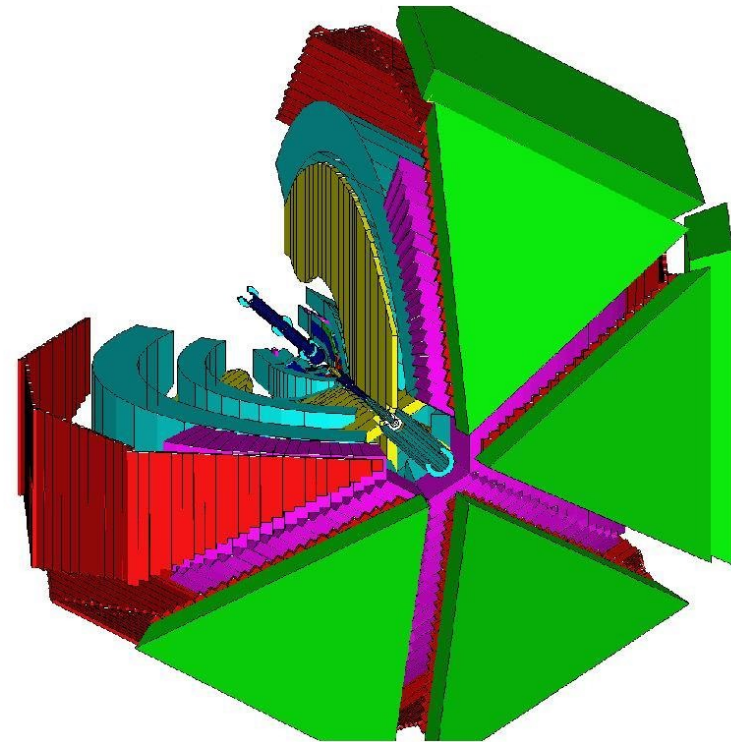

CEBAF Large Acceptance Spectrometer

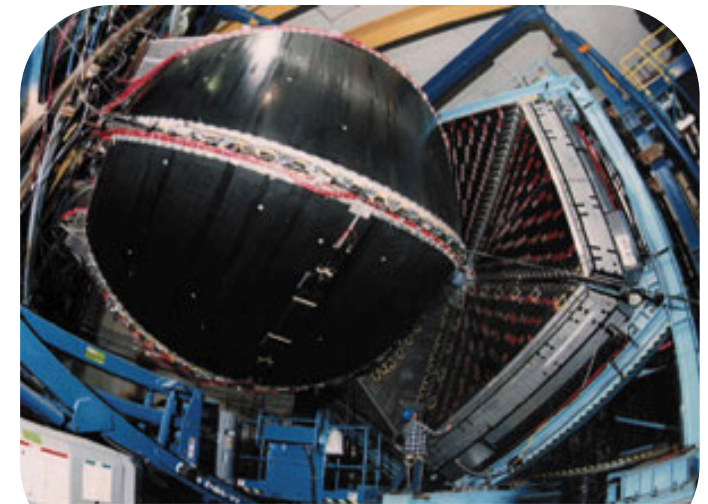
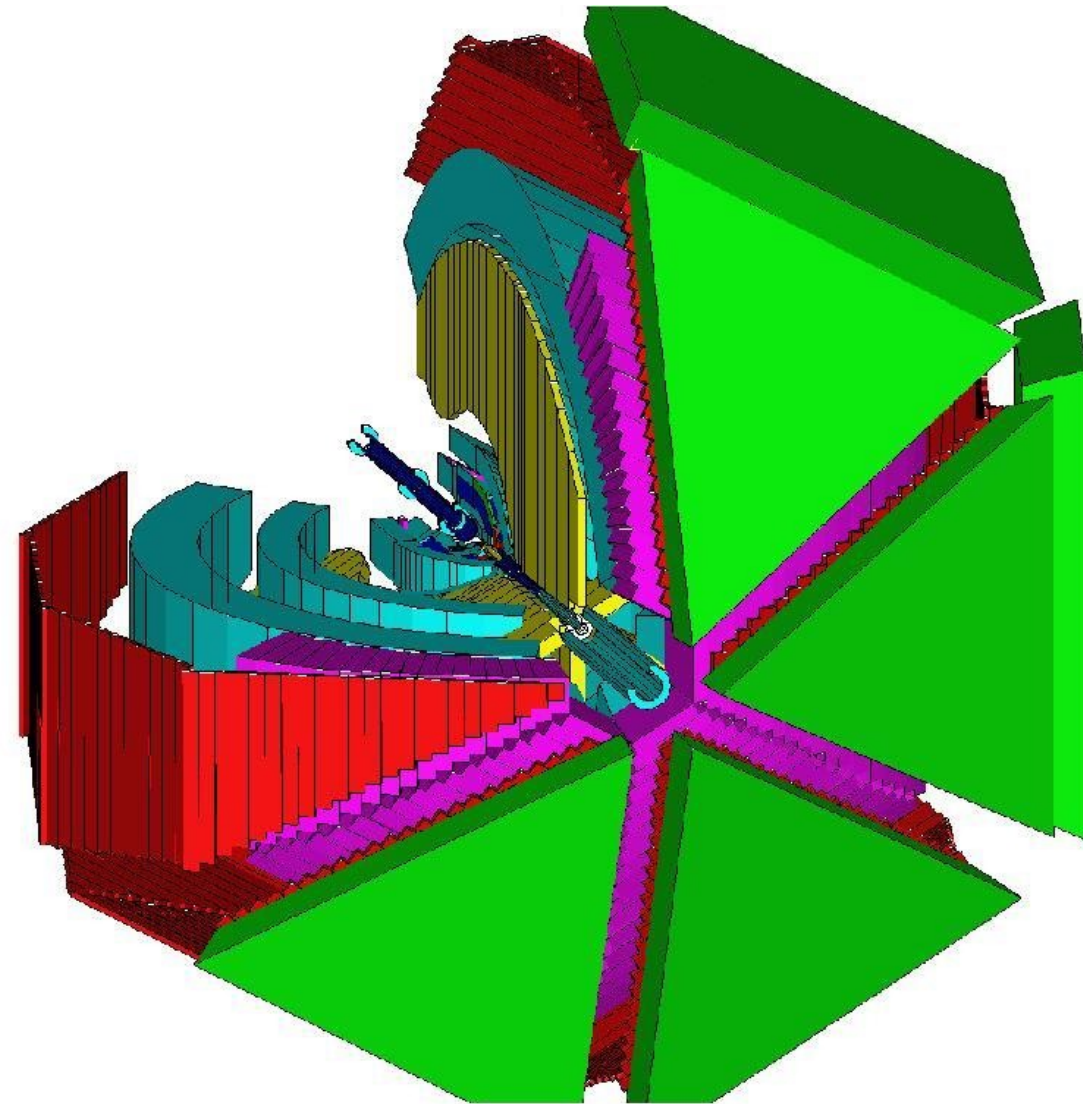

Hall B Large Acceptance Spectrometer

Open (e,e') trigger, Large-Acceptance, Low luminosity ($\sim 10^{34} \text{ cm}^{-2} \text{ sec}^{-1}$)

Electrons, Protons, and Neutrons!

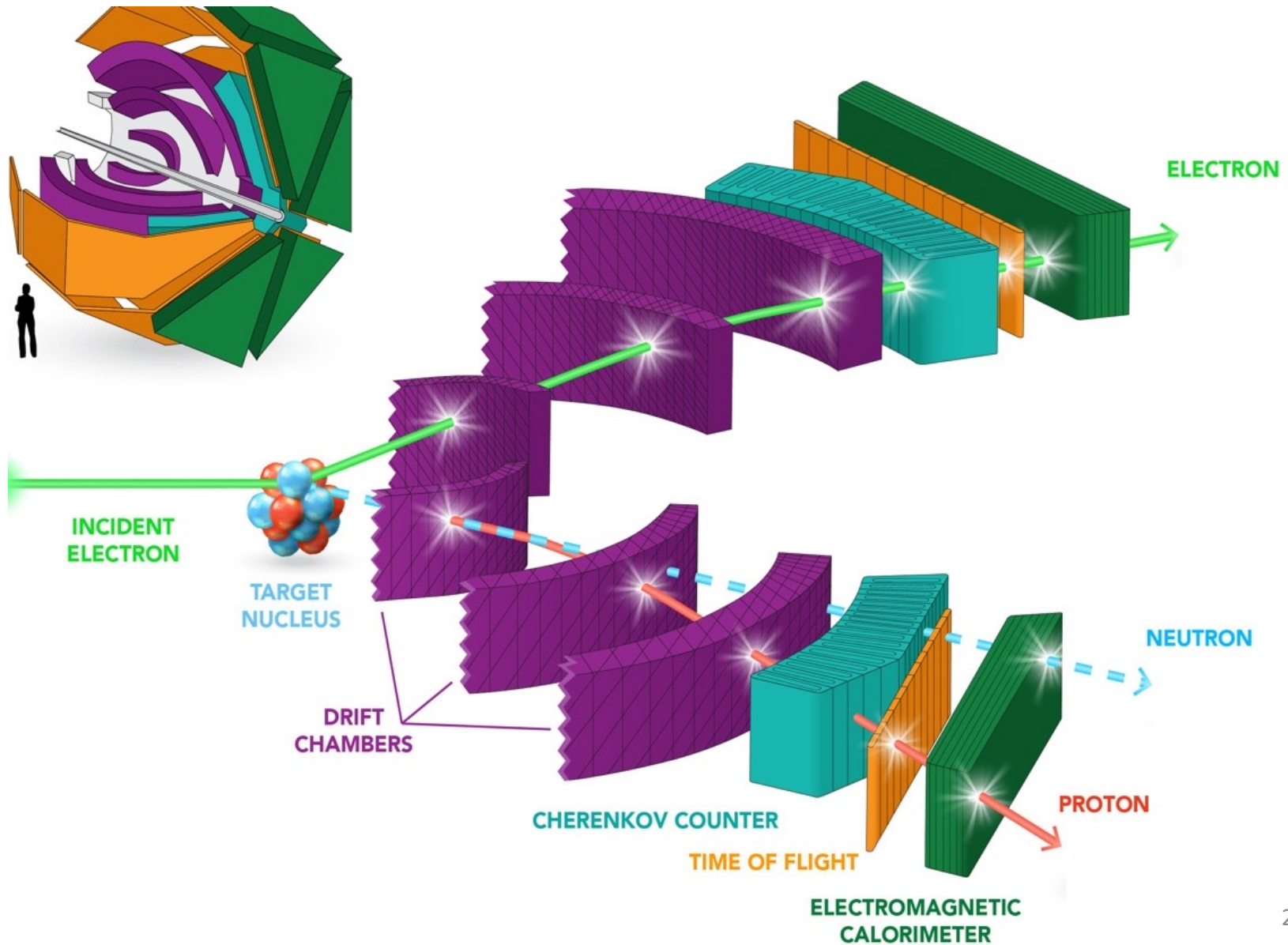

Correlated Proton-Neutron pair is Back-to-Back

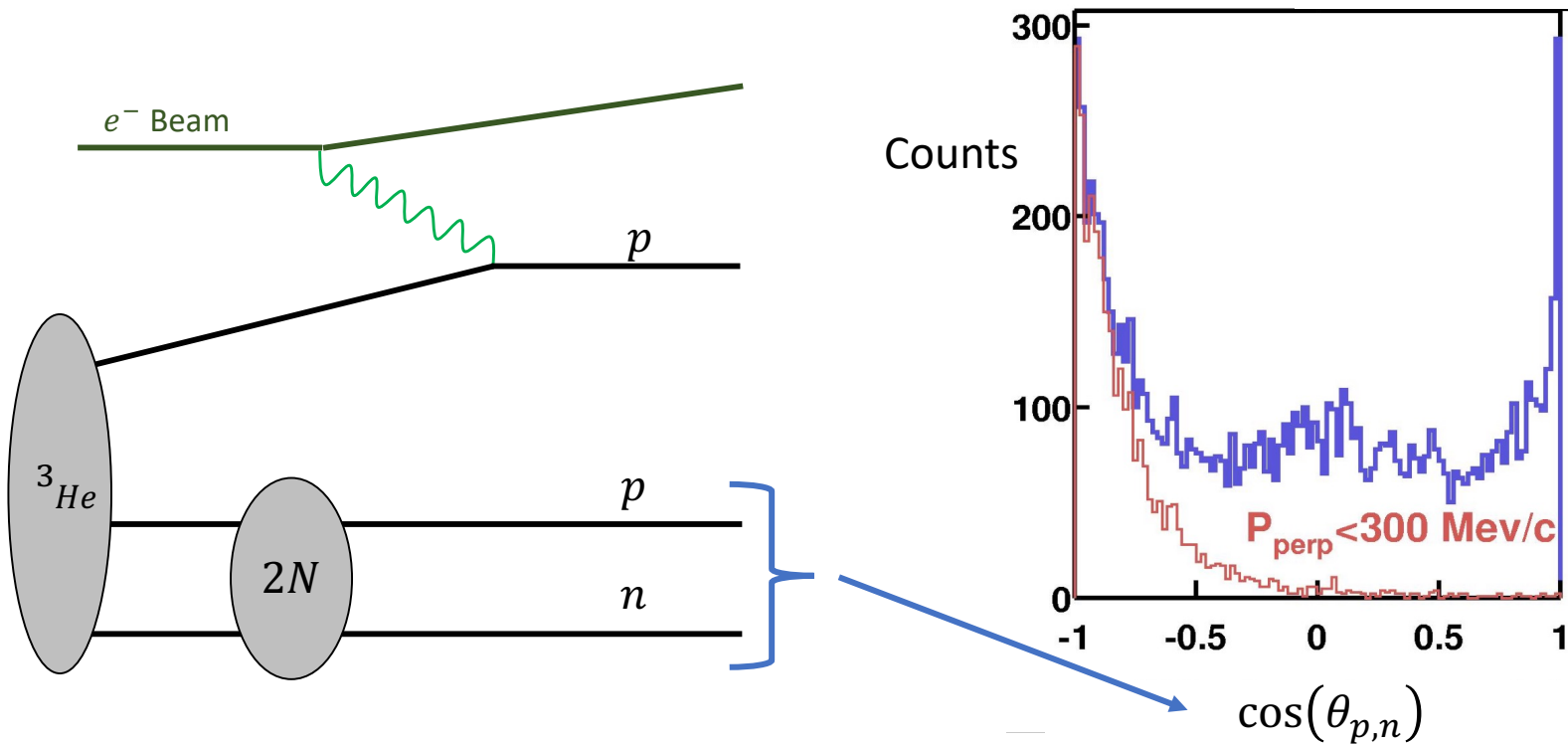

- Baghdasaryan, PRL (2010)

This Analysis Only Works for ${}^3\text{He}$

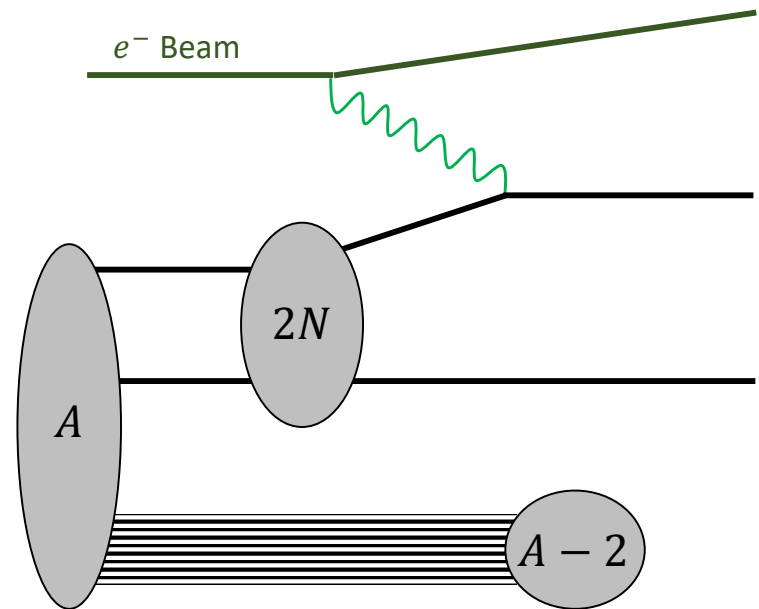
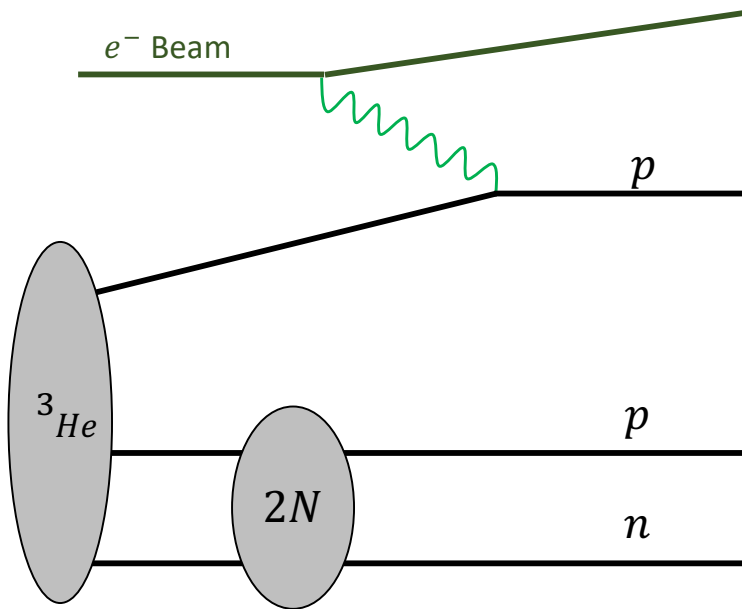

First Data Mining Analysis (e,e'pp) and (e,e'pn)

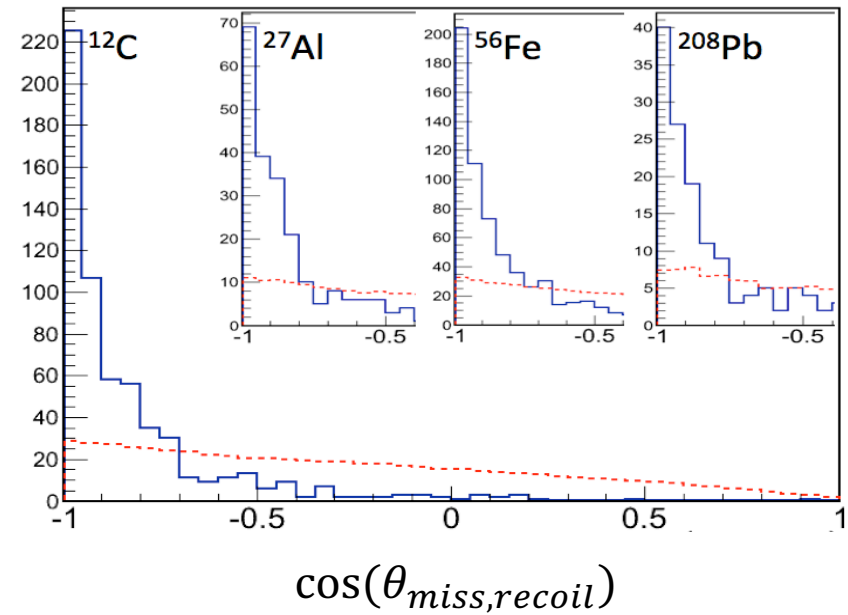
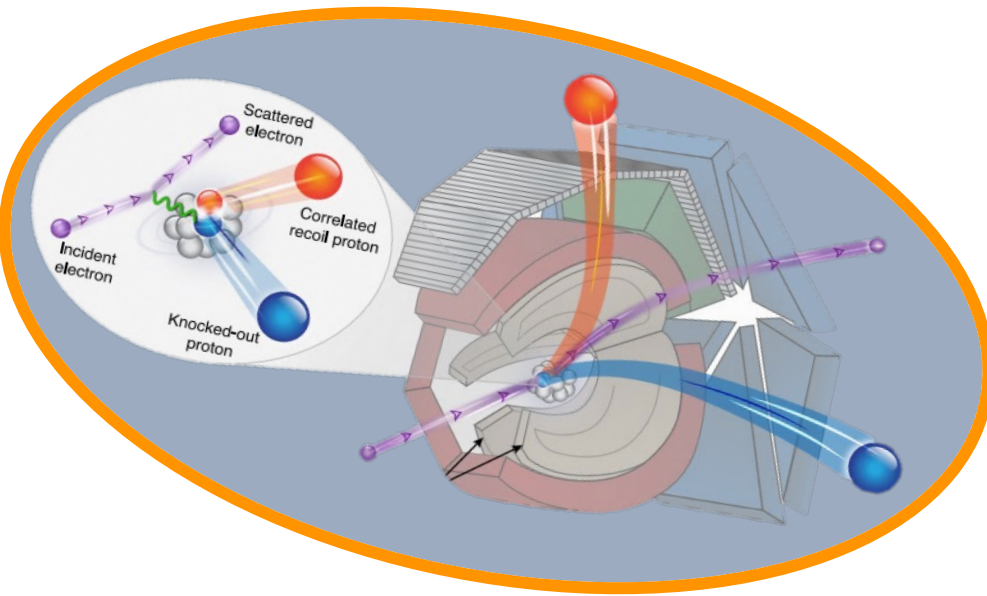

- Hen, Science (2014)

First Exclusive SRC Results for Heavy Nuclei

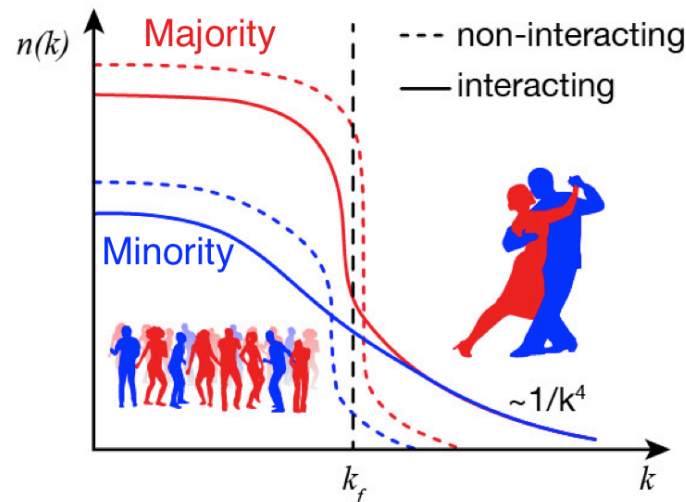
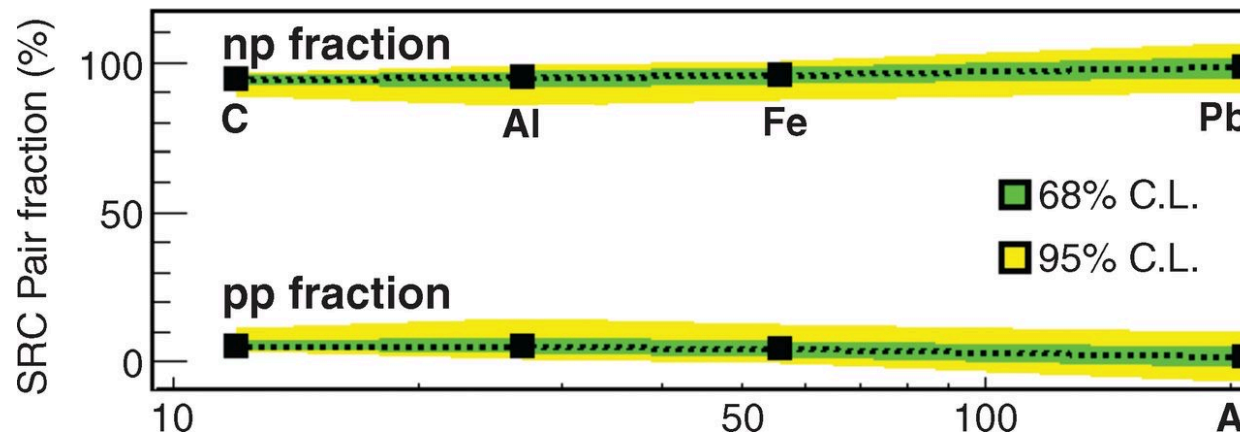

- Hen, Science (2014)

Center of Mass Motion

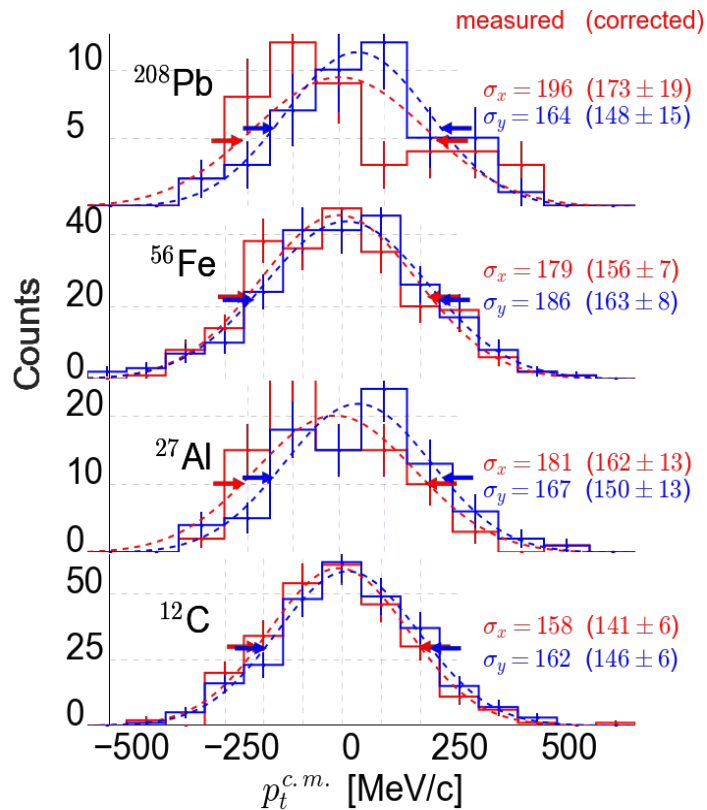

- Cohen, PRL (2018)

Center of Mass Motion

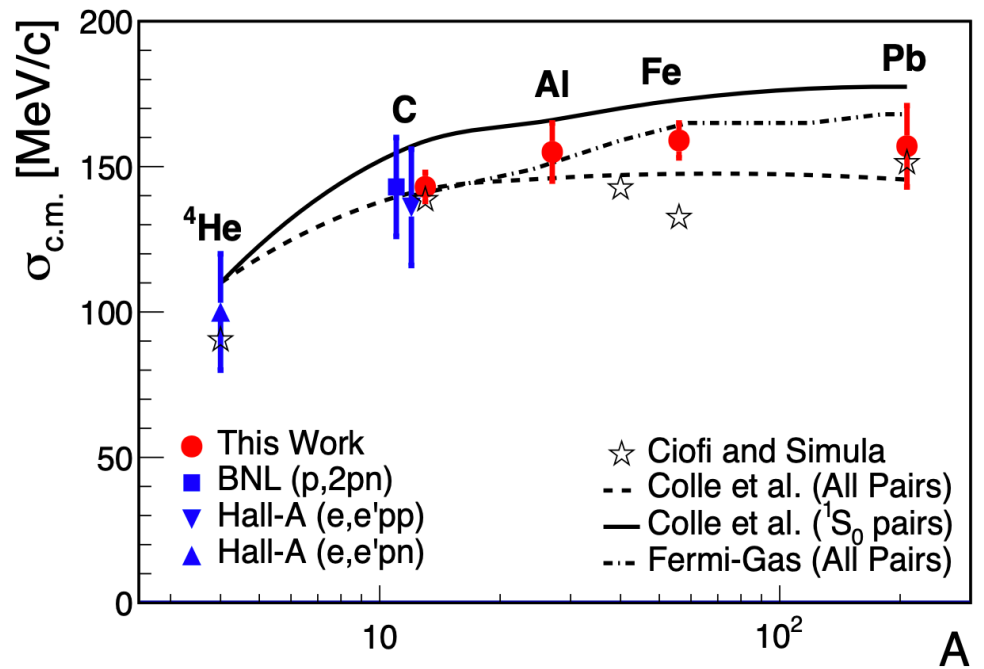
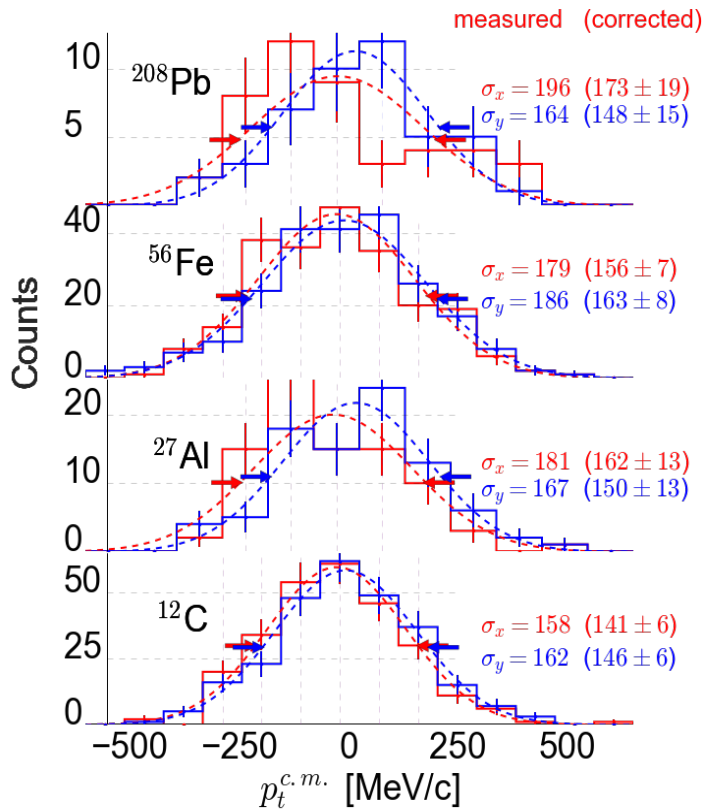

- Cohen, PRL (2018)

What do we see?

- High momentum nucleons with correlated partners.

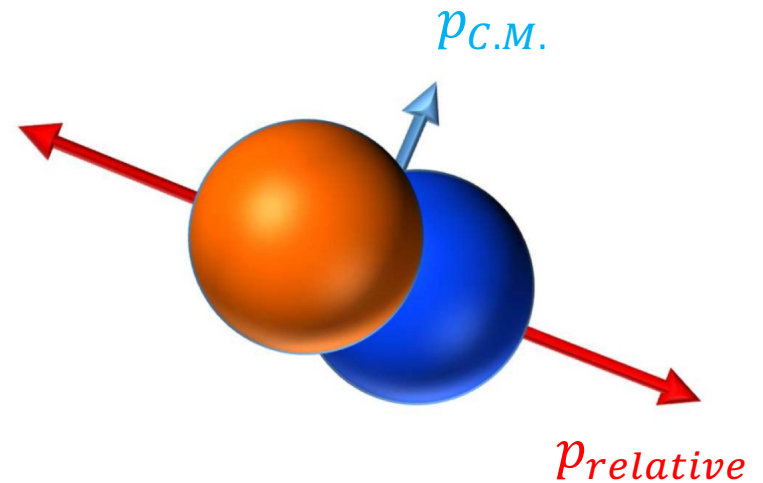

What do we see?

- High momentum nucleons with correlated partners.
- Center of Mass momentum is small in comparison.

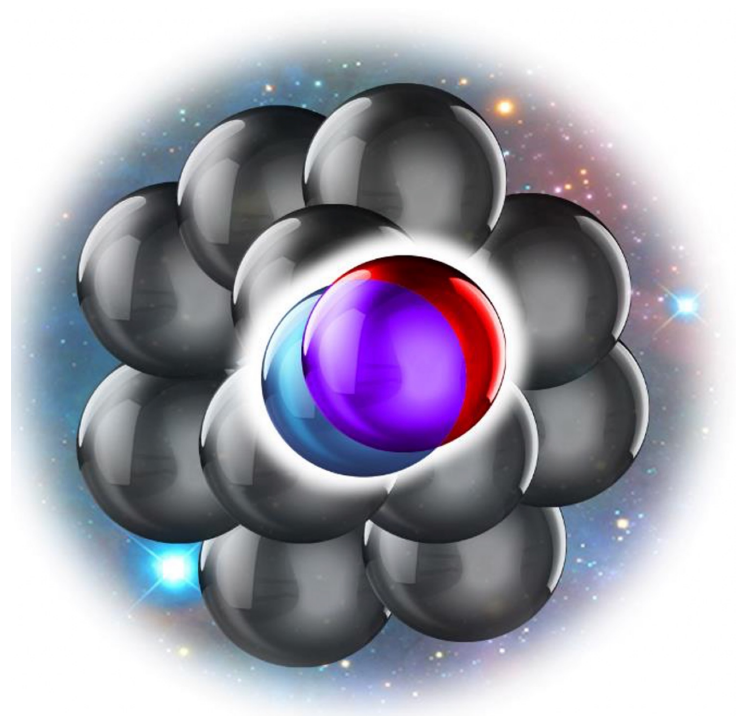

What do we see?

- High momentum nucleons with correlated partners.
- Center of Mass momentum is small in comparison.
- The the pair is decoupled from the A-2 system.

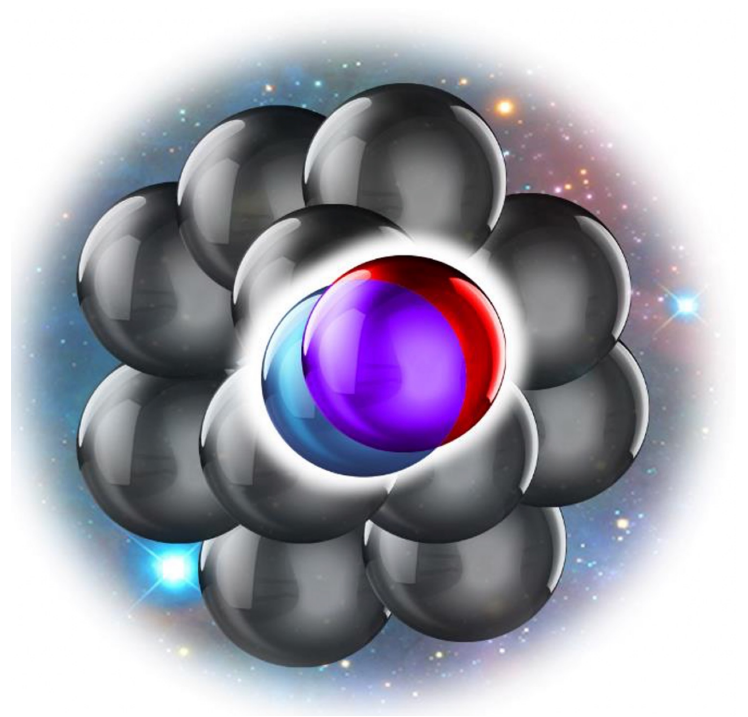

Overview of Exclusive SRC Measurements

- First Exclusive Measurements
- CLAS6: The Perfect Detector for SRCs
- **Generalized Contact Formalism**

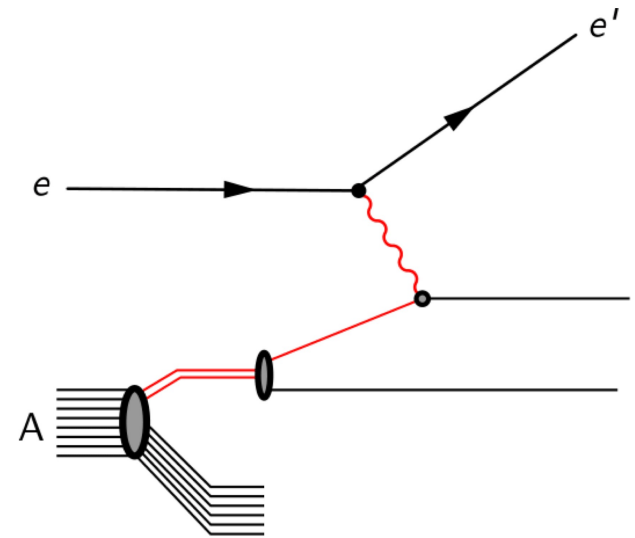

Generalized Contact Formalism

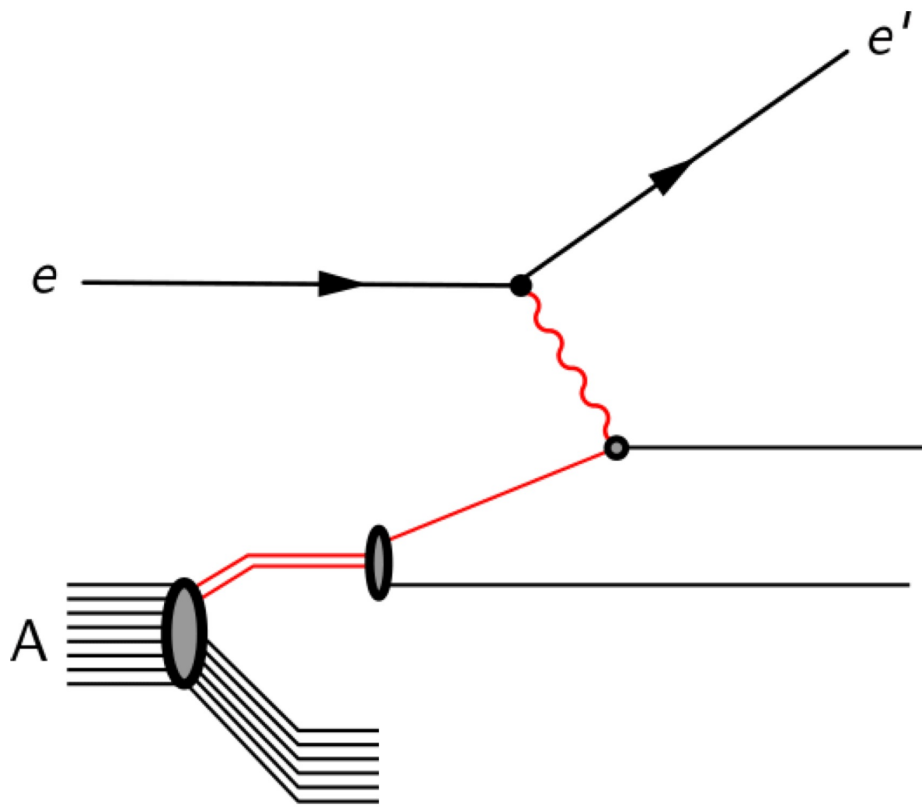

Generalized Contact Formalism

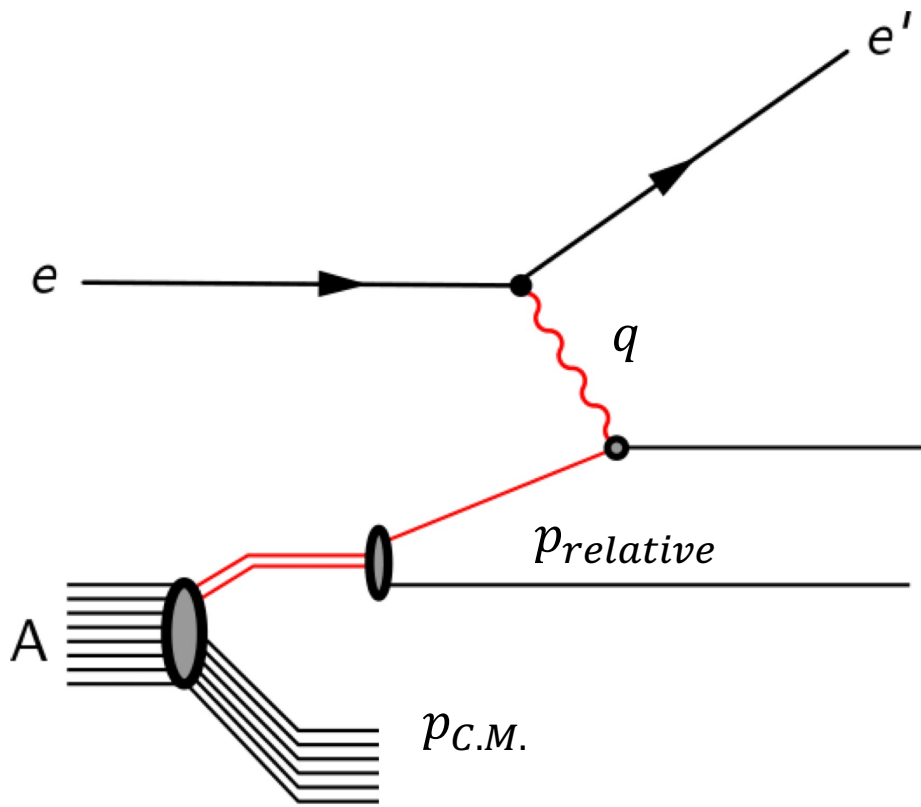

Generalized Contact Formalism

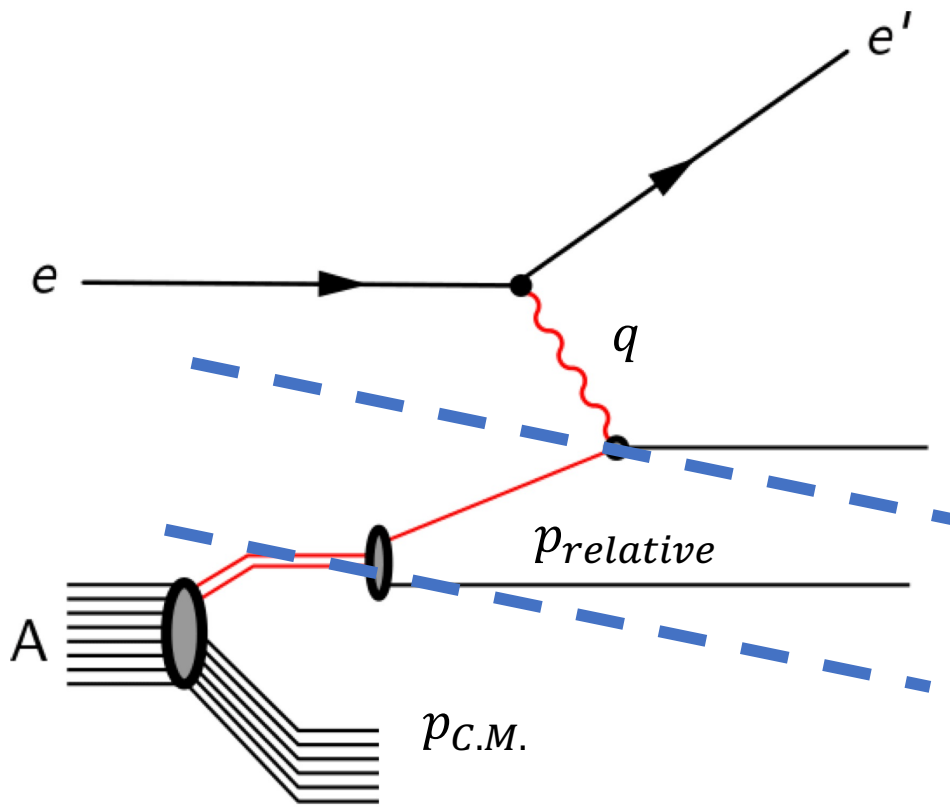

Generalized Contact Formalism

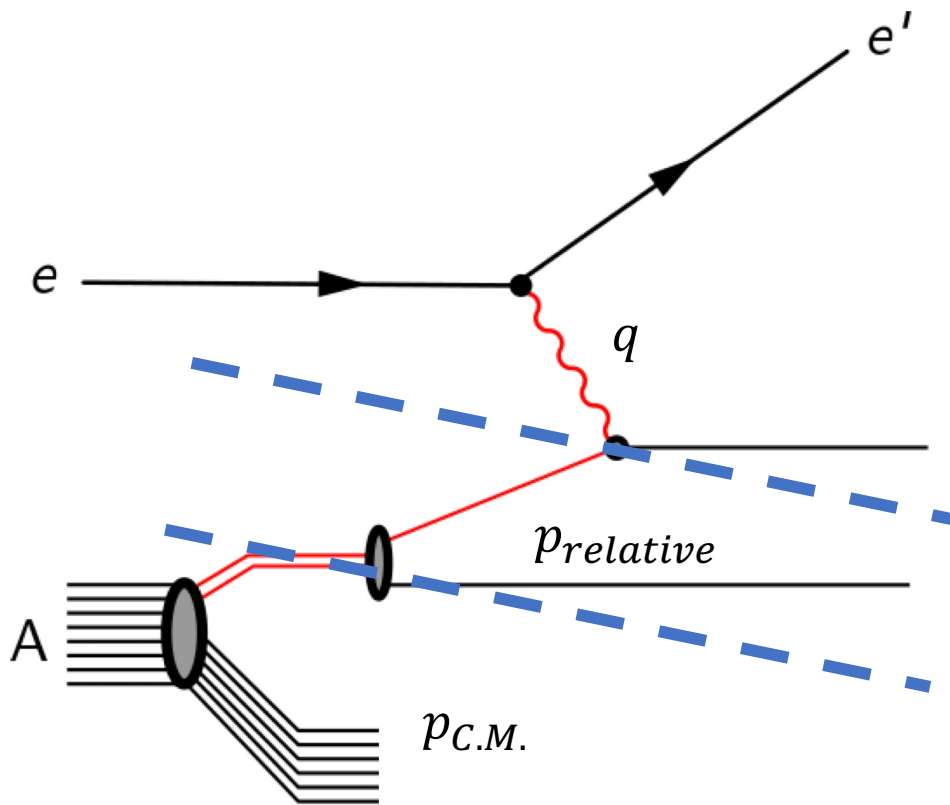

$$q \gg p_{relative} \gg p_{C.M.}$$

Generalized Contact Formalism

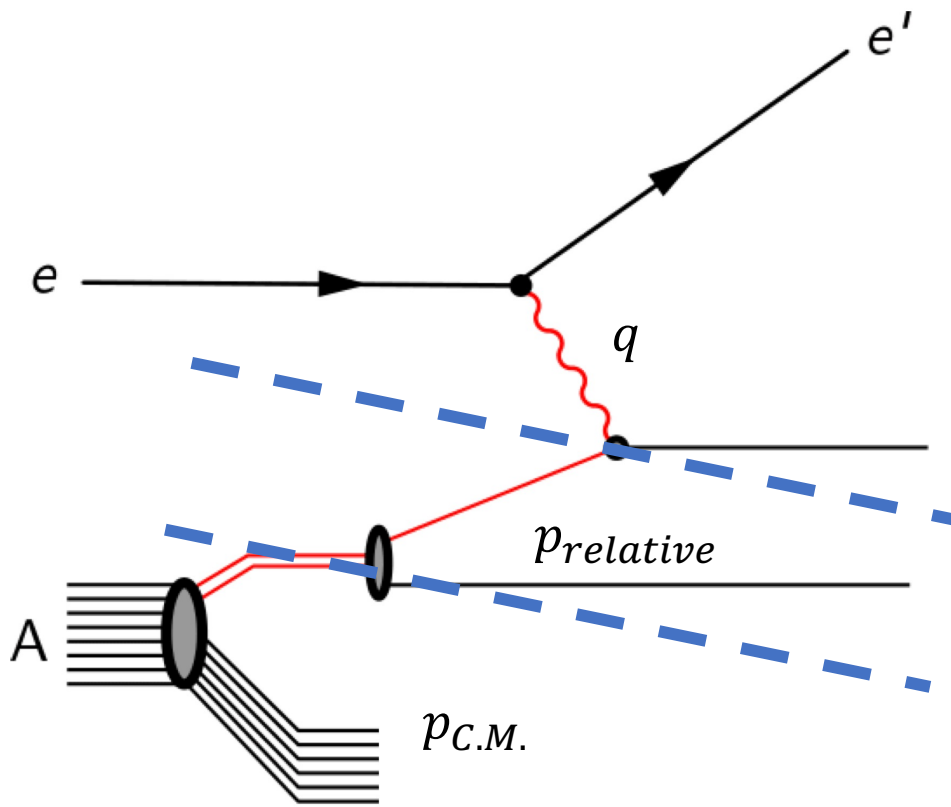

$$q \gg p_{relative} \gg p_{C.M.}$$

$$\sigma = \sigma_{e,N}(q) \sum_{\alpha} \phi(p_{relative})^2 C^{\alpha n}(p_{C.M.})$$

Generalized Contact Formalism

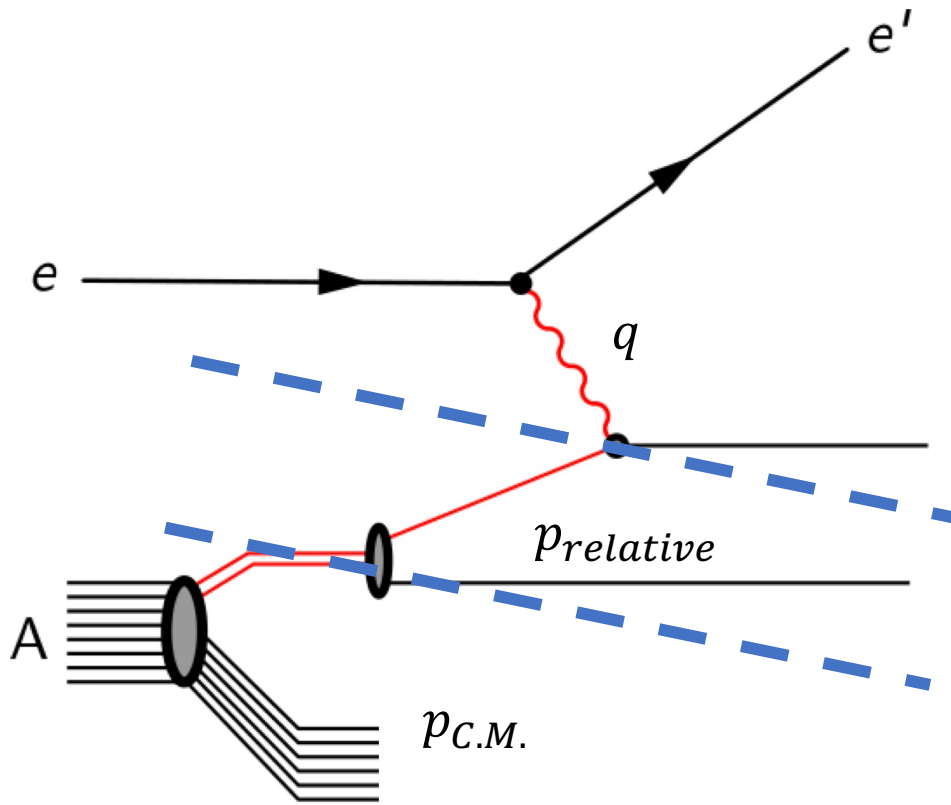

$$q \gg p_{relative} \gg p_{C.M.}$$

$$\sigma = \sigma_{e,N}(q) \sum_{\alpha} \phi(p_{relative})^2 C^{\alpha n}(p_{C.M.})$$

Components of the SRC

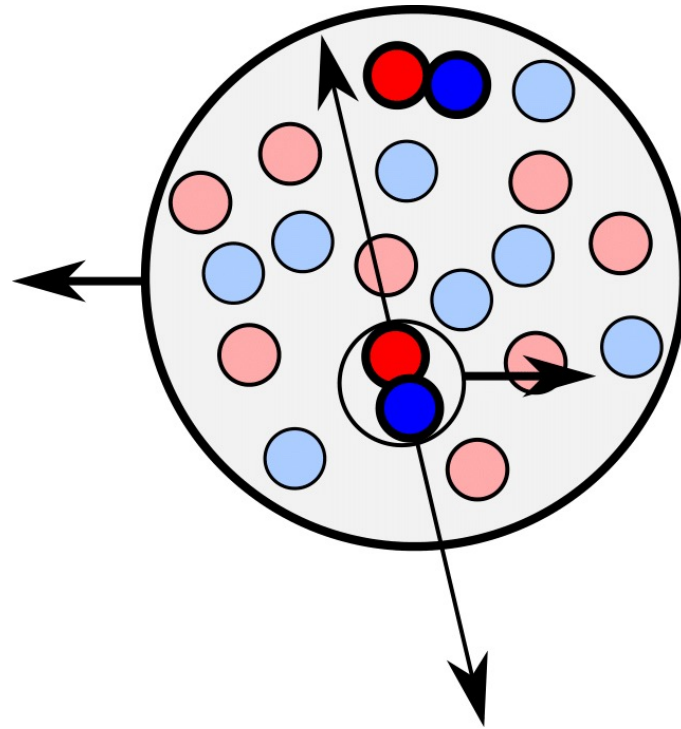

Components of the SRC

Pair Abundance

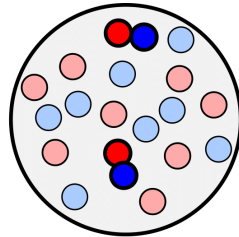

Components of the SRC

Pair Abundance

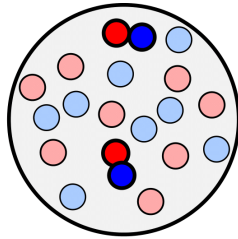

Center of
Mass Motion

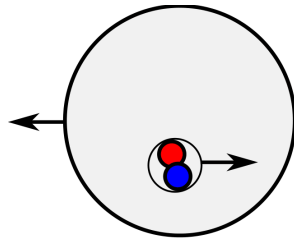

Components of the SRC

Pair Abundance

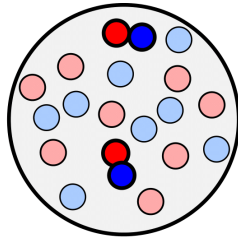

Center of Mass Motion

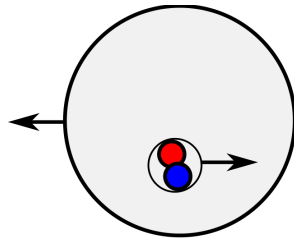

Pair Interaction

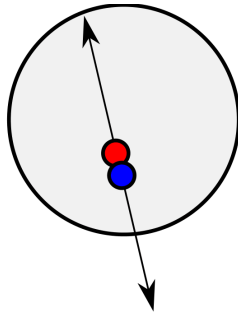

Components of the SRC

Pair Abundance

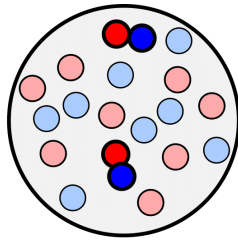

Center of Mass Motion

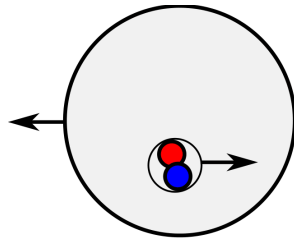

Pair Interaction

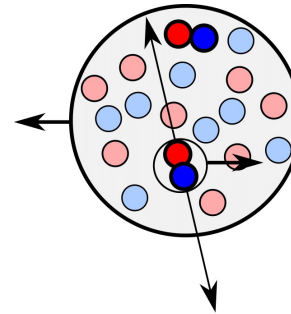
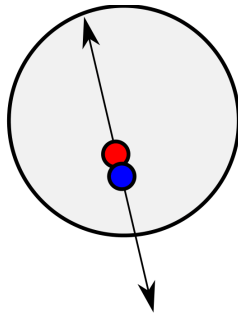

SRC Component of the Wave-Function

Components of the SRC

Pair Abundance

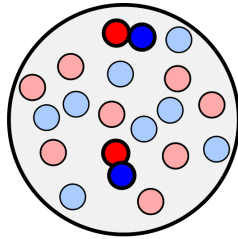

Center of Mass Motion

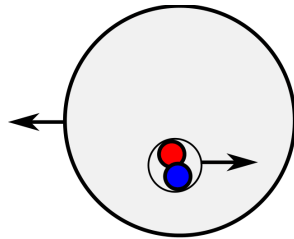

Pair Interaction

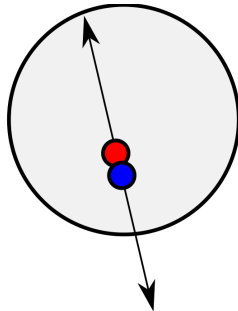

- How abundant are SRCs?
- What kinds of SRCs dominate?
- Do SRCs move in the nucleus?
- Can we learn anything about the NN interaction?

Components of the SRC

Pair Abundance

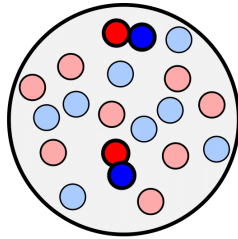

Center of Mass Motion

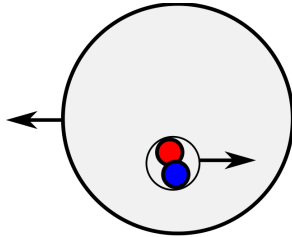

Pair Interaction

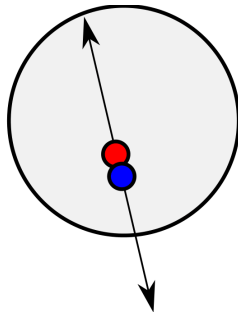

- How abundant are SRCs?
- What kinds of SRCs dominate?
- Do SRCs move in the nucleus?
- Can we learn anything about the NN interaction?

Components of the SRC

Pair Abundance

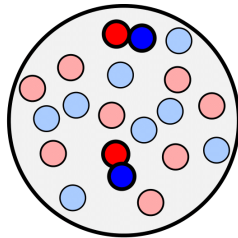

Center of Mass Motion

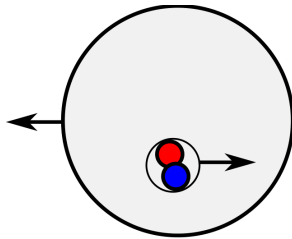

Pair Interaction

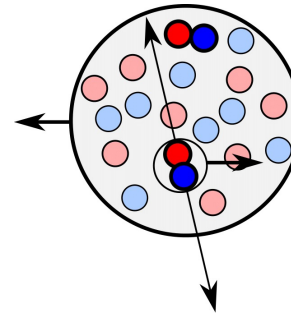
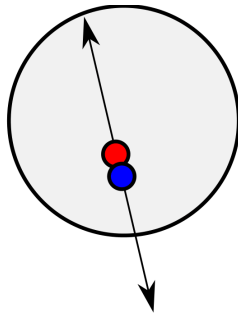

Factorized
Wave-Function

Components of the SRC

Pair Abundance

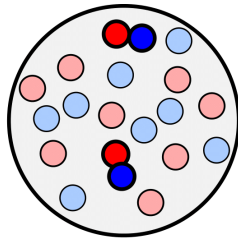

Center of Mass Motion

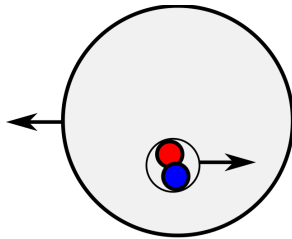

Pair Interaction

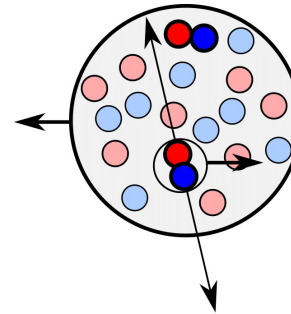
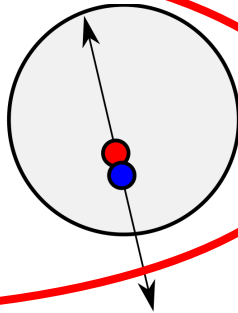

Factorized Wave-Function

Tensor to Scalar

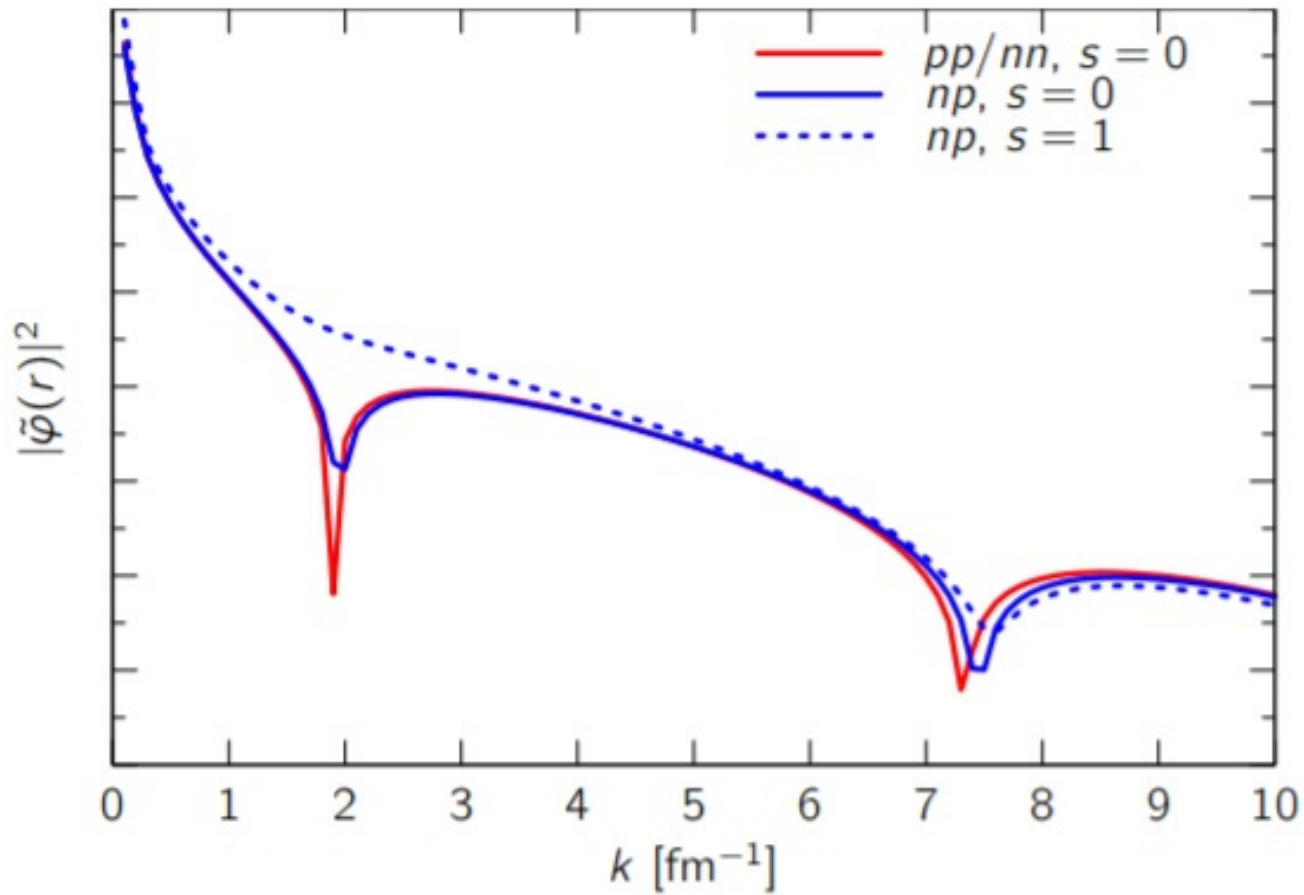
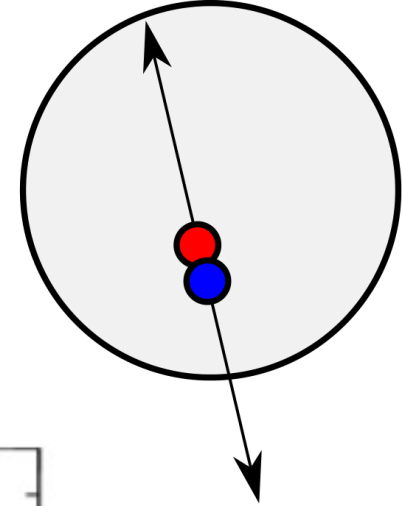

Full Theory Calculations

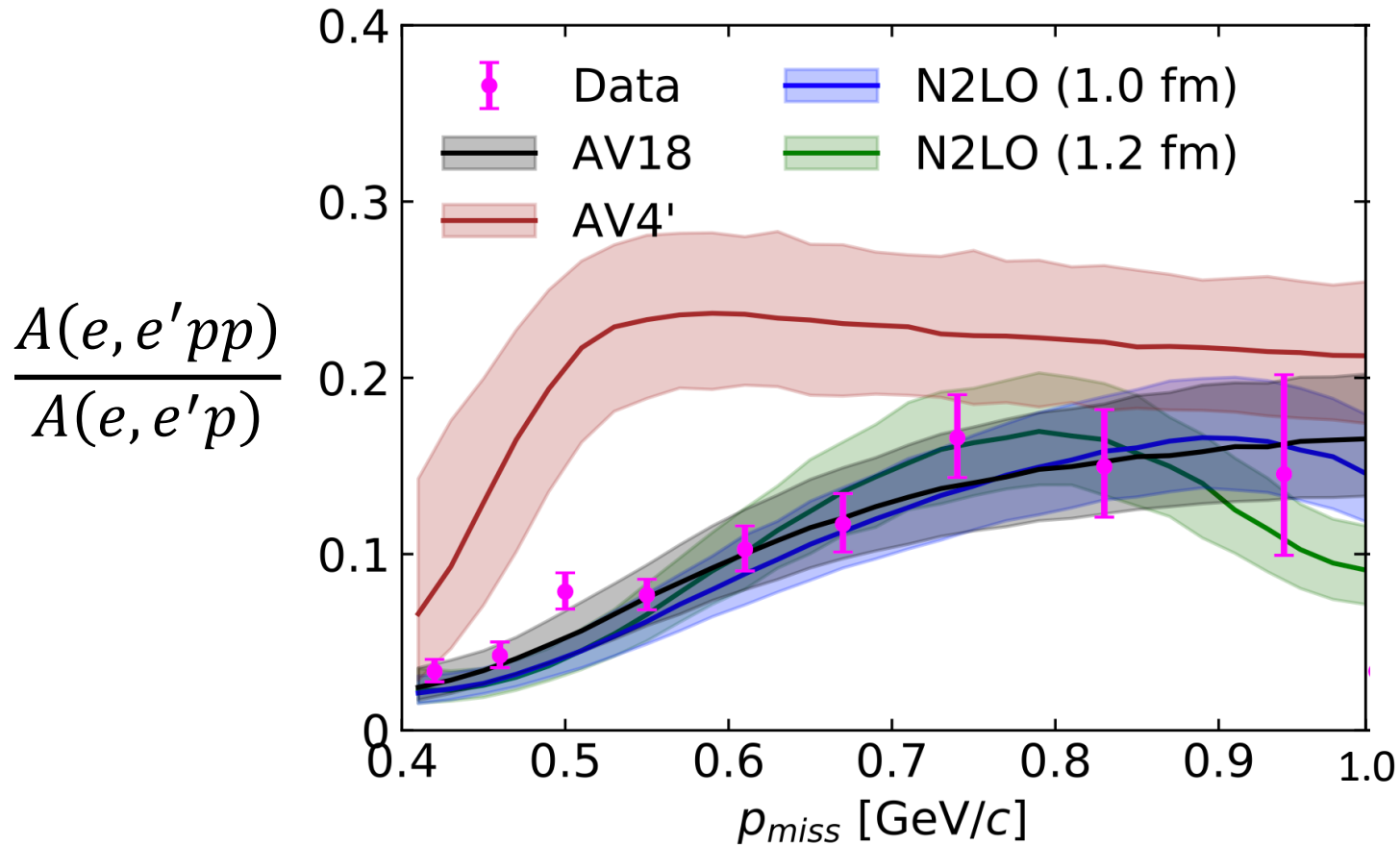
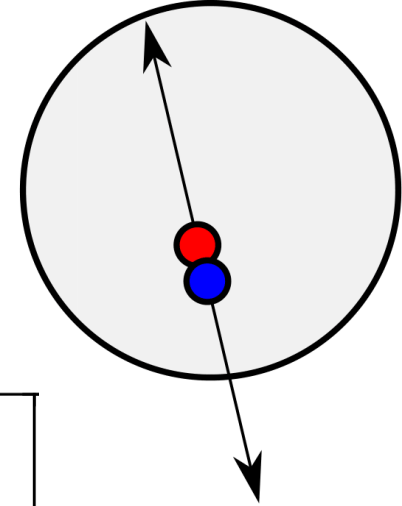

- Schmidt, Nature (2020)

Consistent Across Nuclei

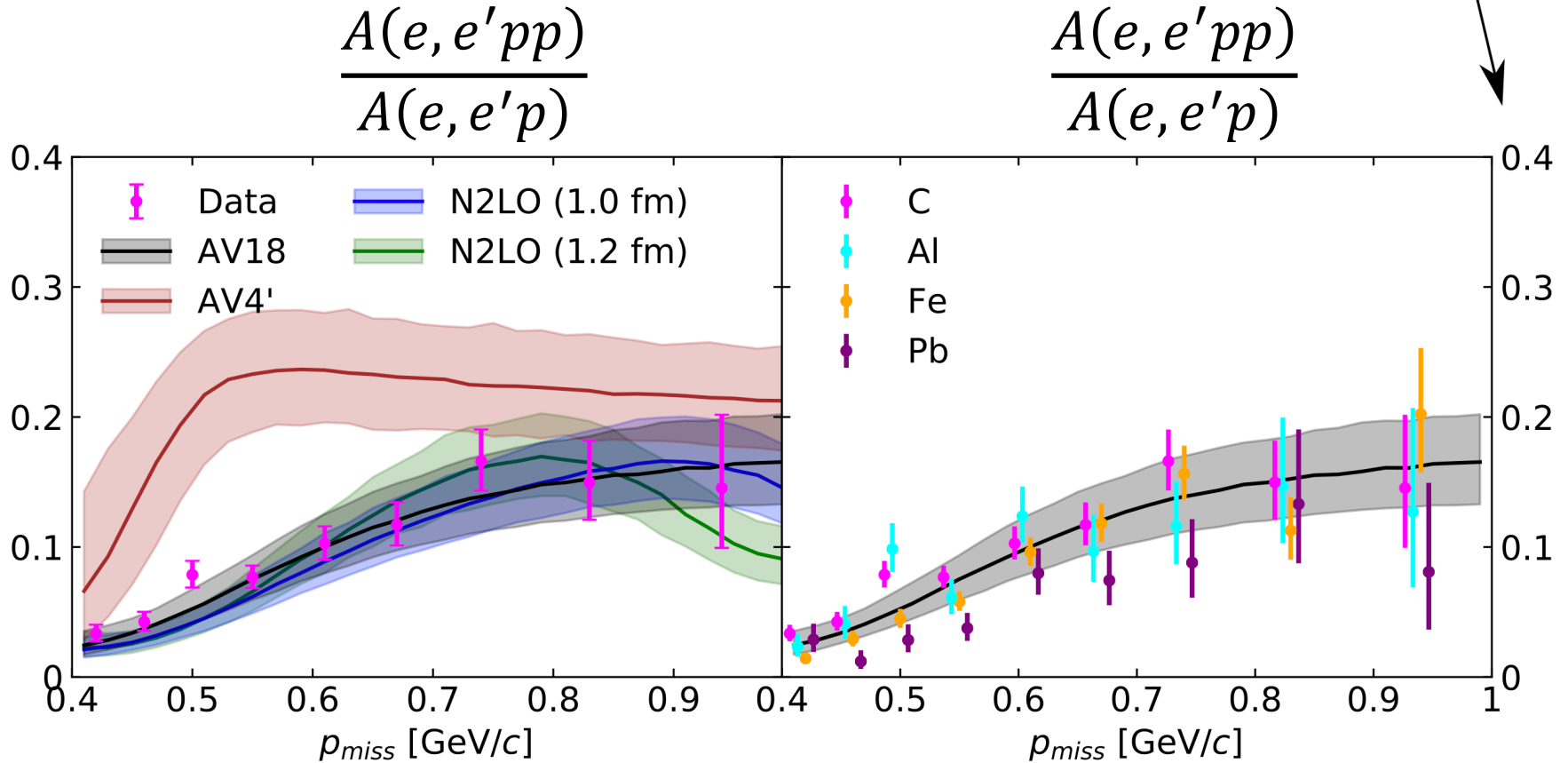
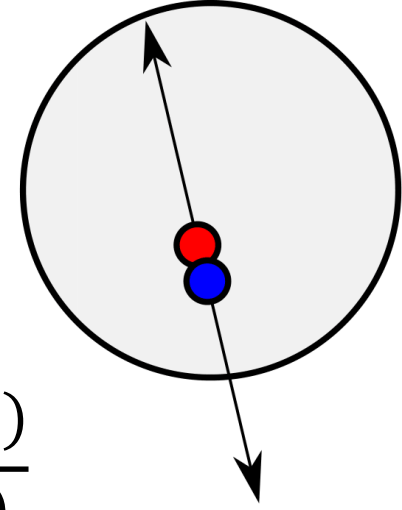

- Schmidt, Nature (2020)

Full Cross Sections Are Necessary

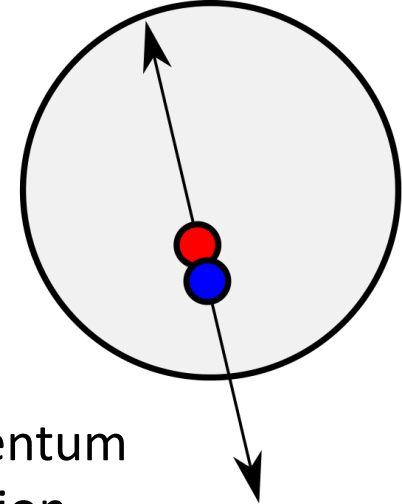

Full Simulation

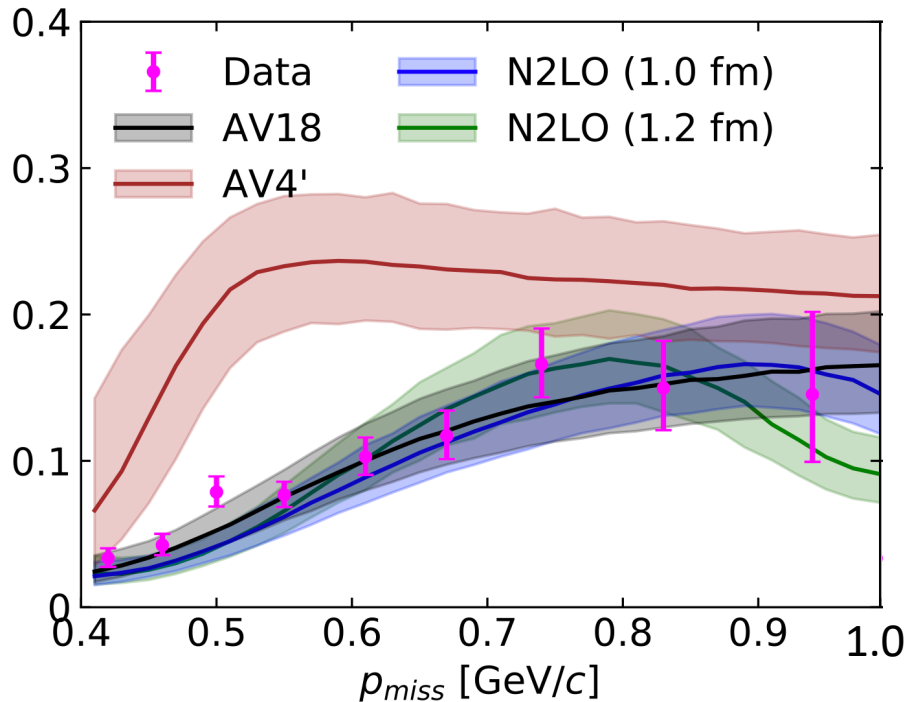

Pure Momentum Distribution

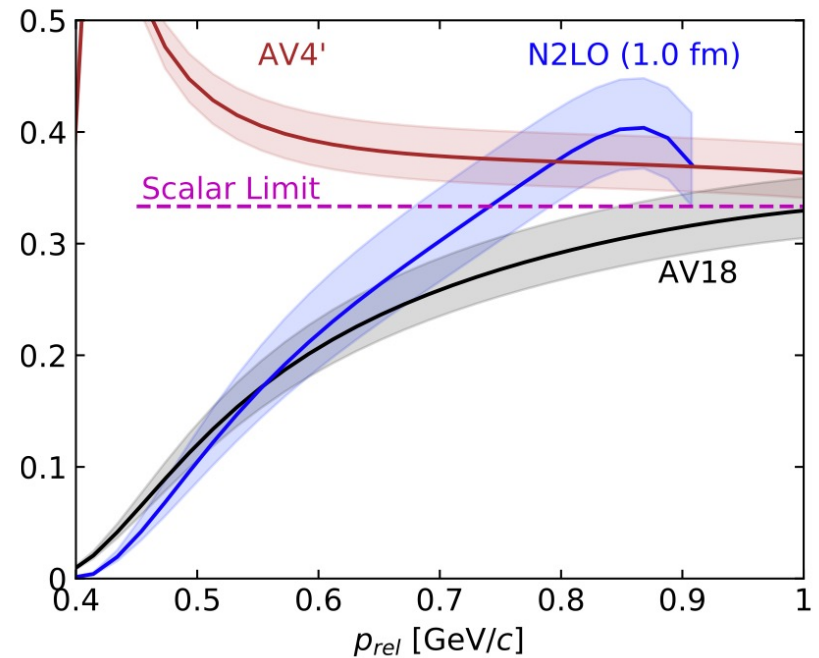

- Schmidt, Nature (2020)

Revisiting Previous Results

$$\frac{A(e, e'pN)}{A(e, e'p)}$$

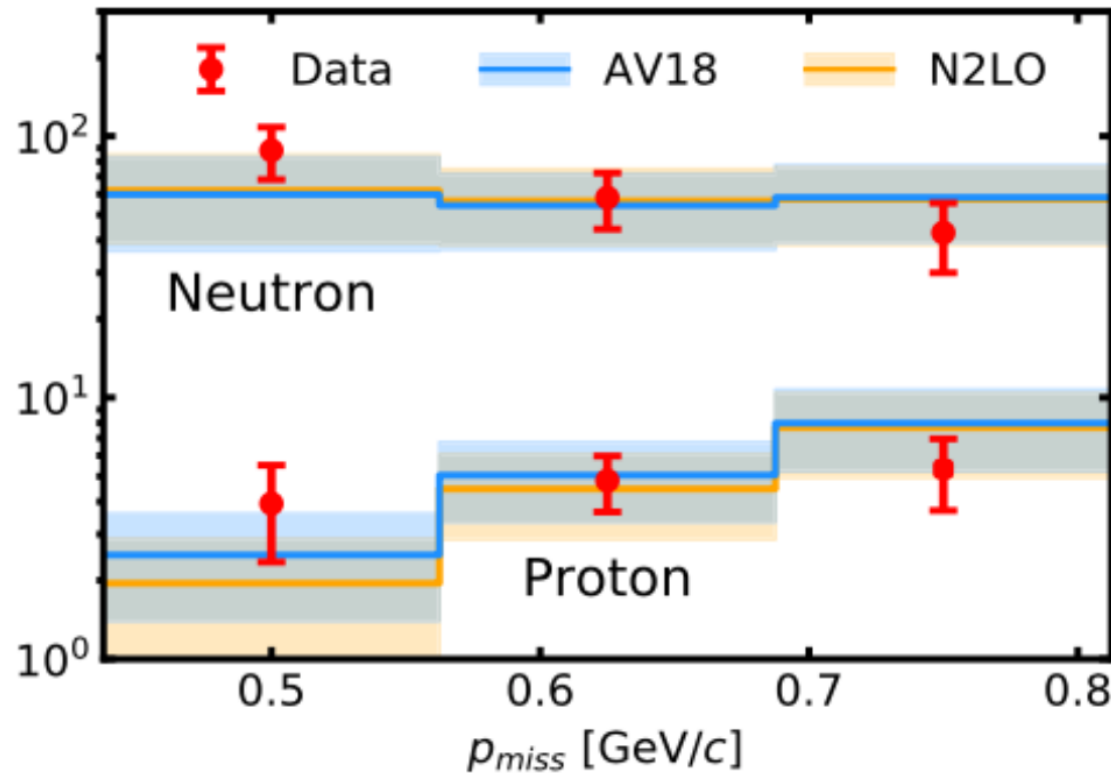
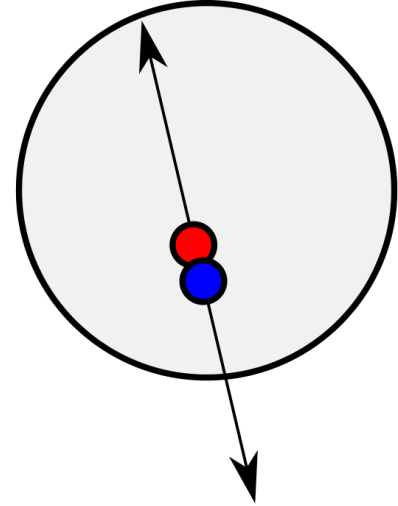

- Pybus, PLB (2020)

Overview of Exclusive SRC Measurements

- First Exclusive Measurements
- CLAS6: The Perfect Detector for SRCs
- Generalized Contact Formalism
- SRC Universality

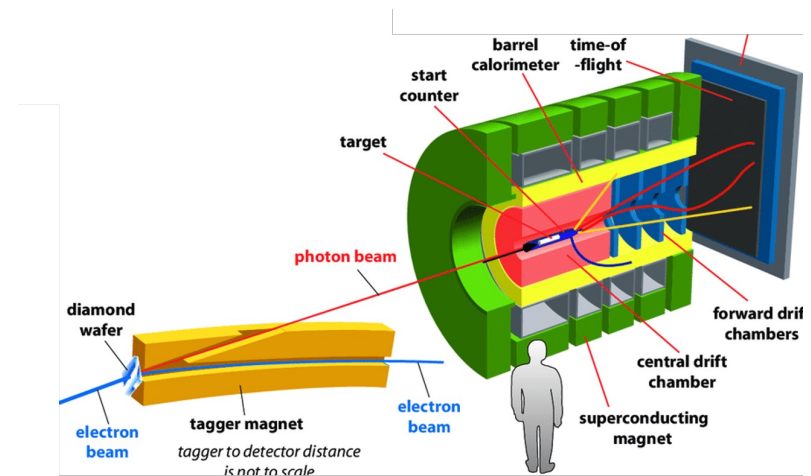

Using Different Probes for SRC Measurements

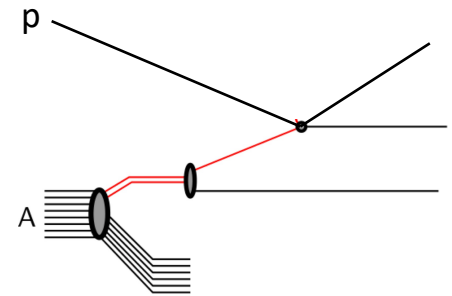
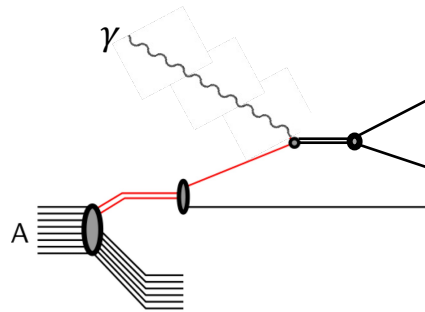
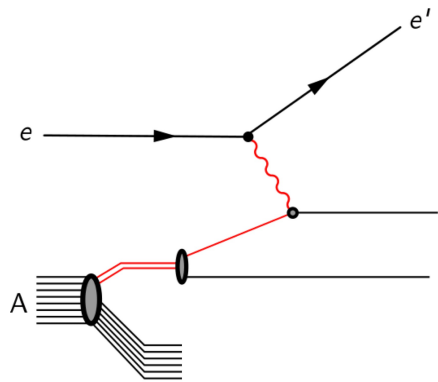

Using Different Probes for SRC Measurements

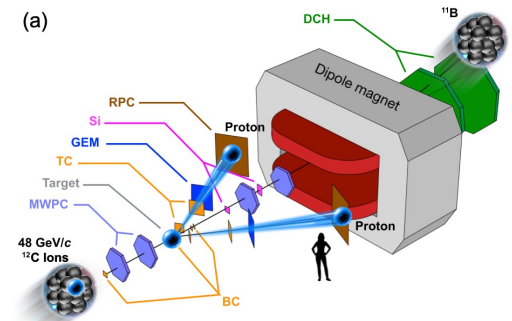
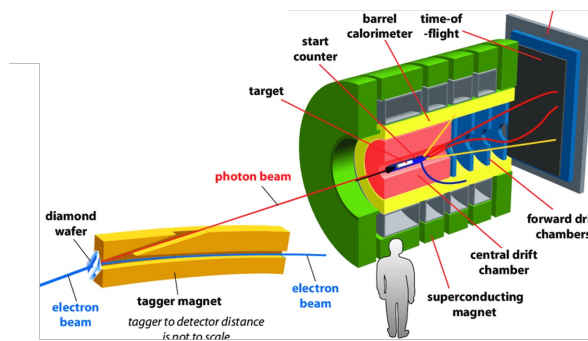
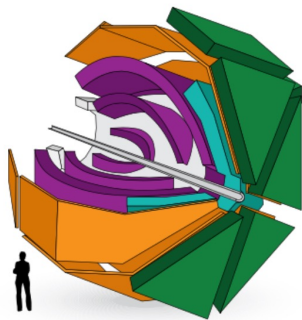
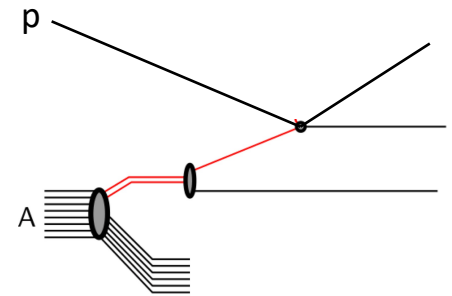
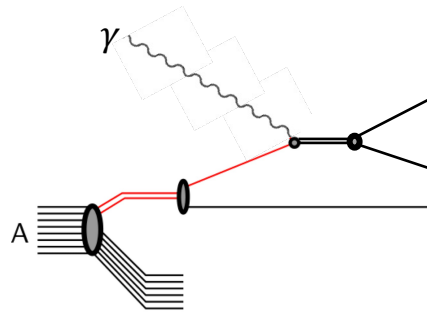
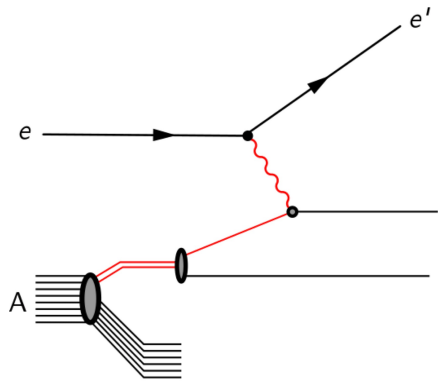

Probing SRCs with Real Photon Beam

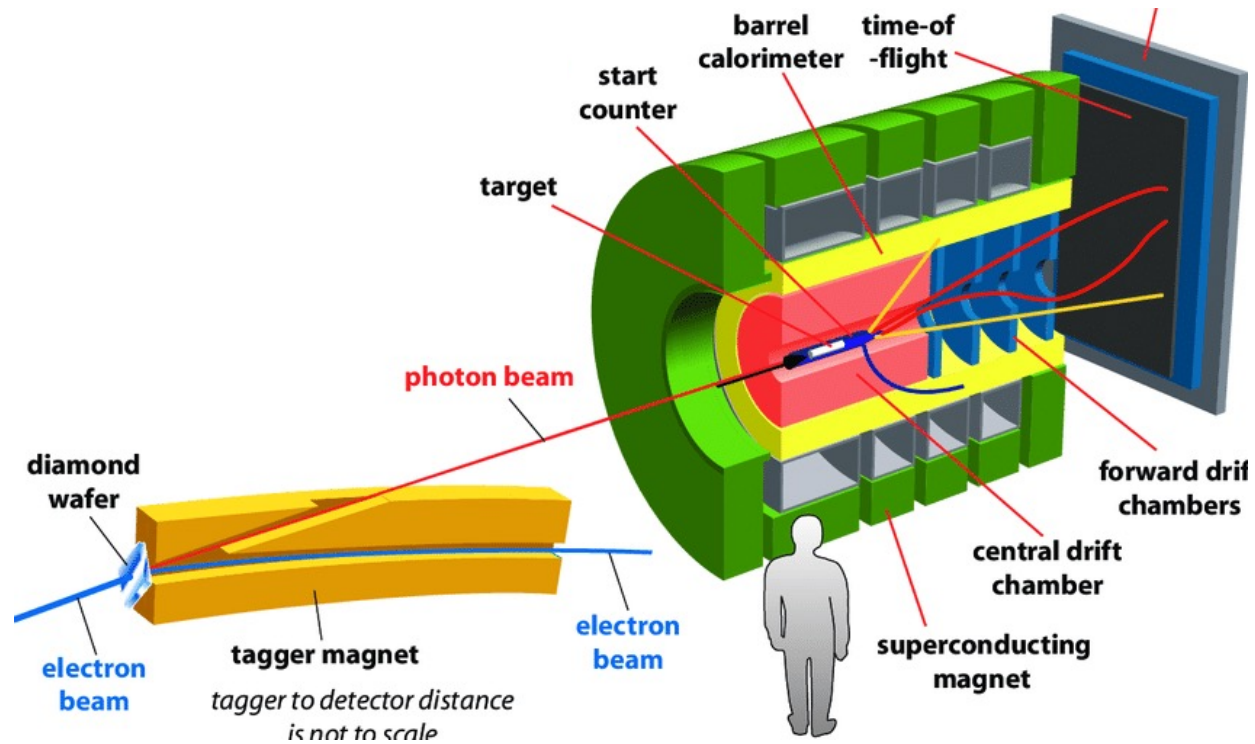

Center of Mass Motion

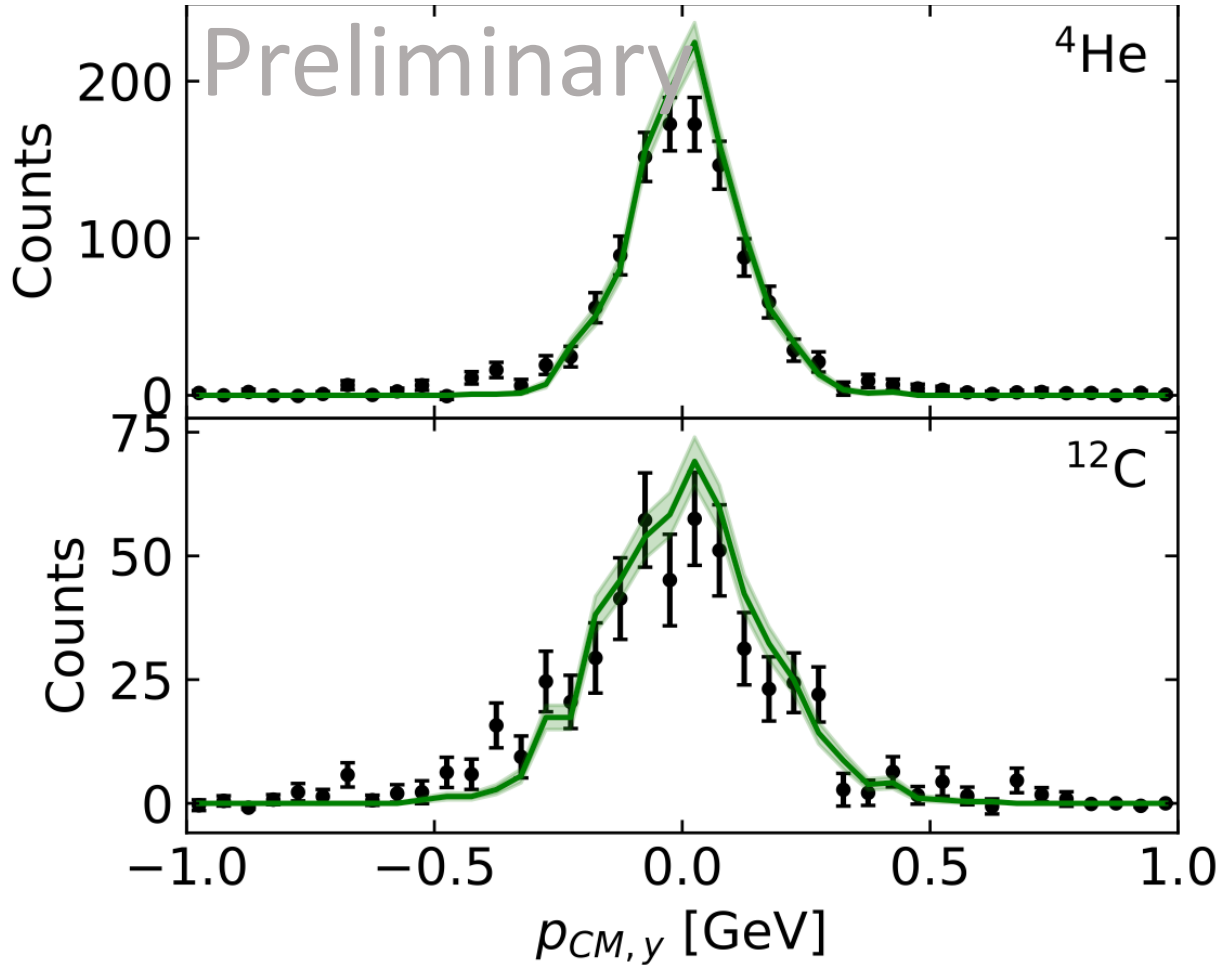
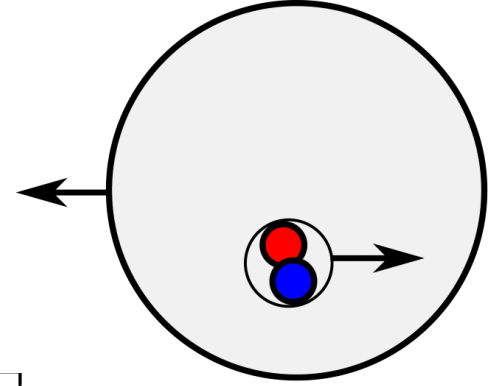
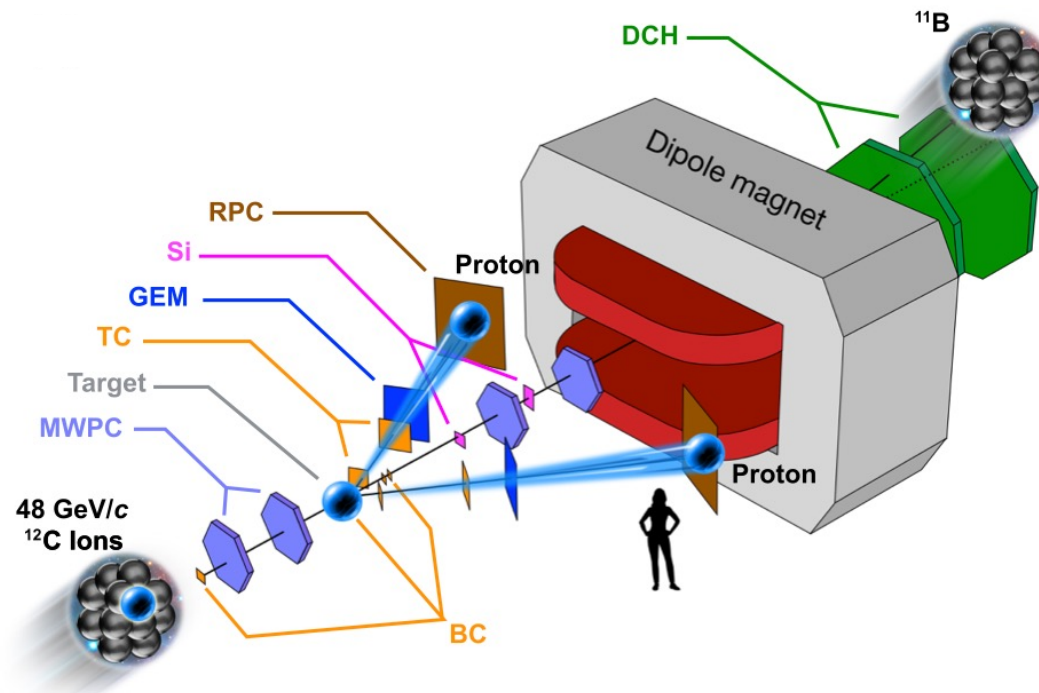
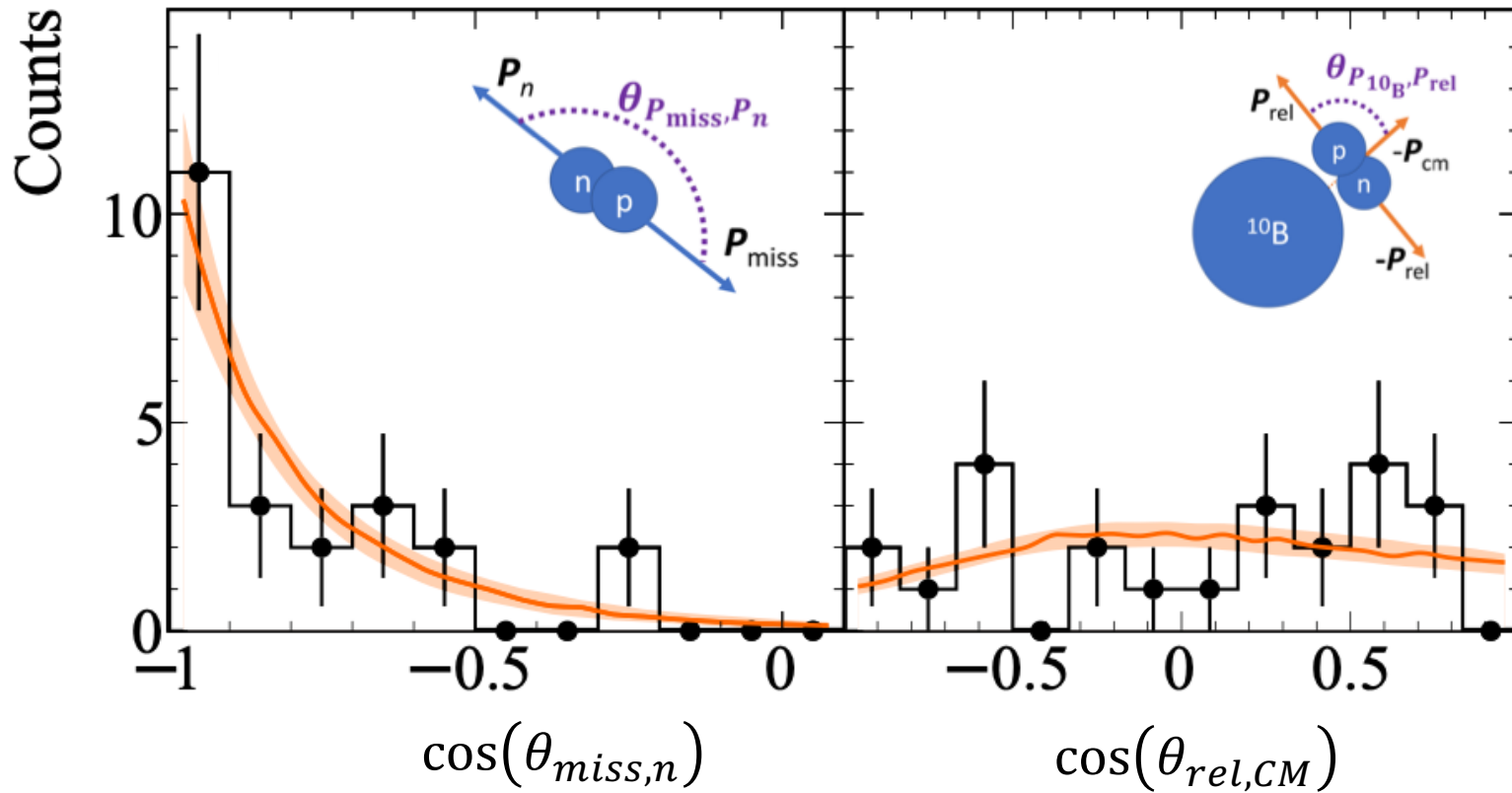
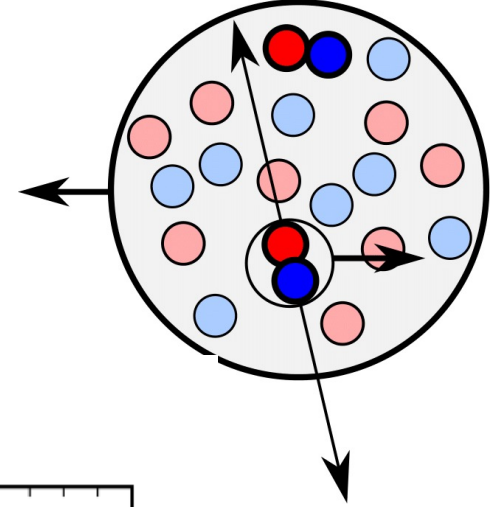

Photo-
production
Data

Probing SRCs with Carbon Beam



SRC Factorization



Inverse
Kinematics
Data

- Patsyuk, Nature Physics (2021)

SRC Universality of Scale

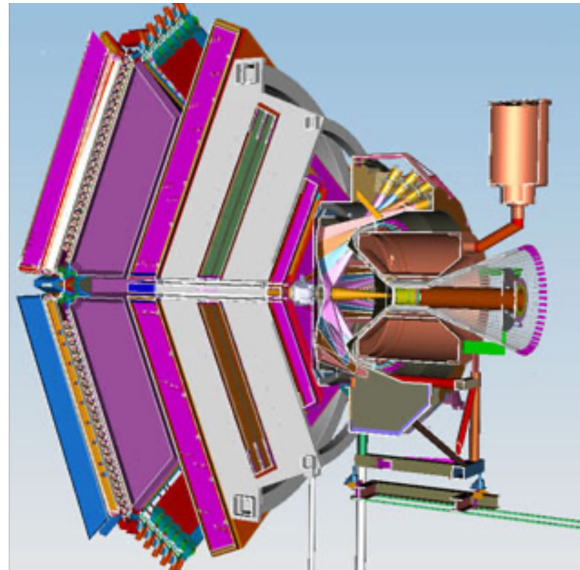

Overview of Exclusive SRC Measurements

- First Exclusive Measurements
- CLAS6: The Perfect Detector for SRCs
- Generalized Contact Formalism
- SRC Universality
- SRCs with CLAS12

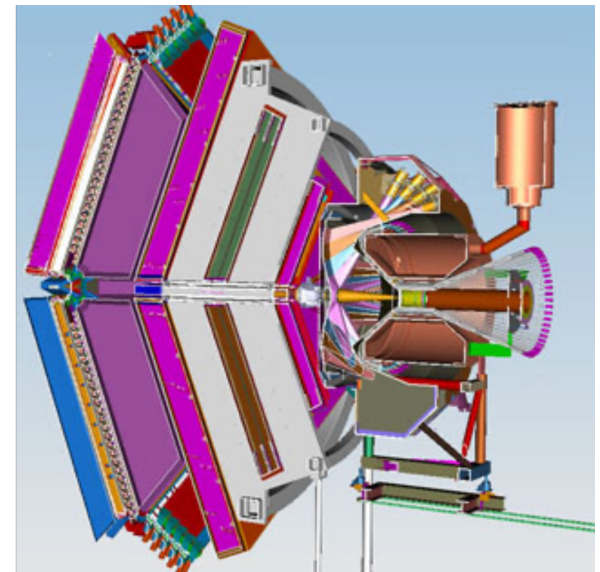

Moving from CLAS6 to CLAS12

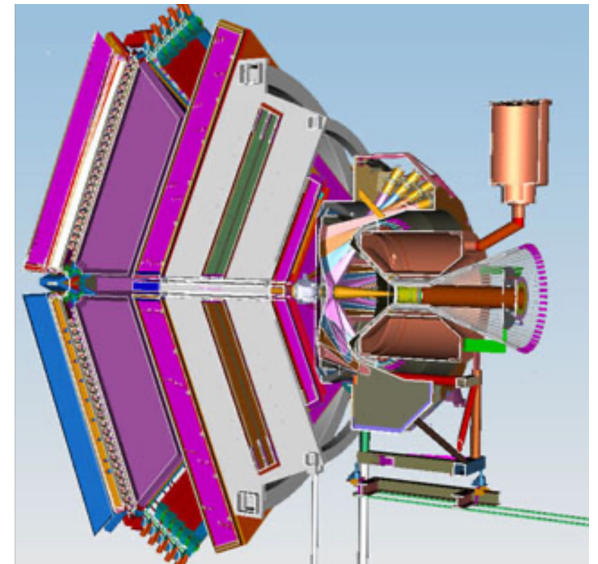
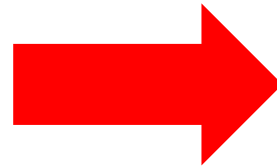
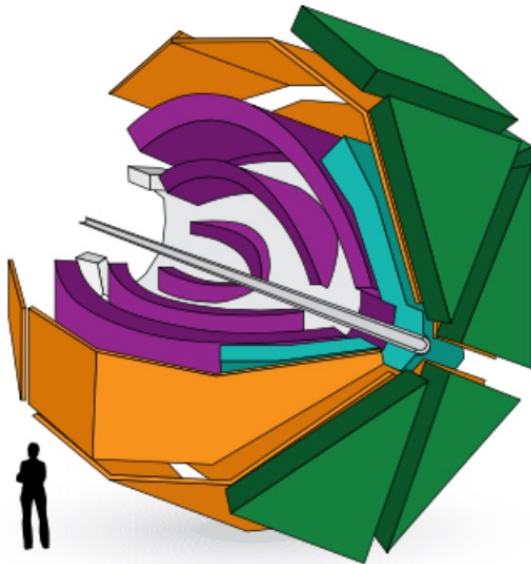

Advantages of CLAS12 to CLAS6

Advantages of CLAS12 to CLAS6

- Cross Check with CLAS6

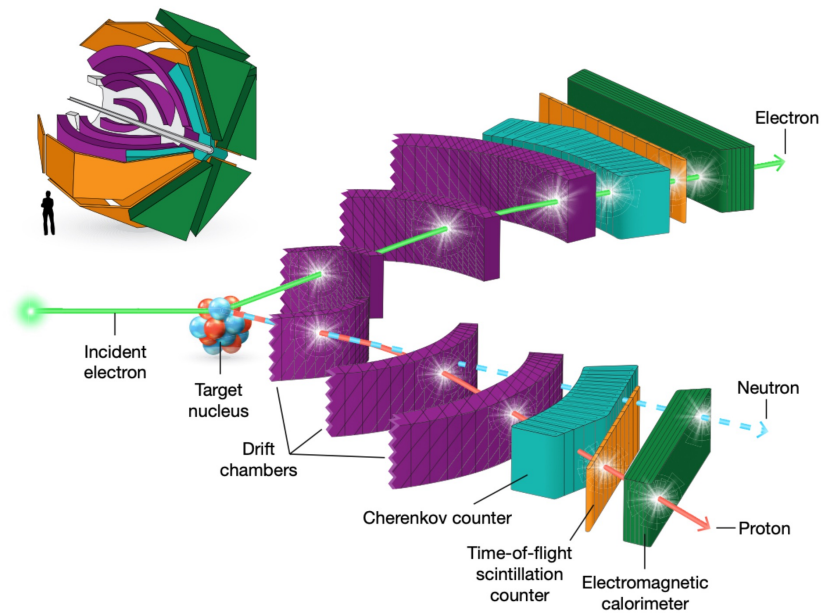

Advantages of CLAS12 to CLAS6

- Cross Check with CLAS6
- High statistics for SRC data
- ${}^4\text{He}$, ${}^{12}\text{C}$, ${}^{40}\text{Ar}$, ${}^{40}\text{Ca}$, ${}^{48}\text{Ca}$, ${}^{120}\text{Sn}$ Targets

Target	Channel	Event Estimate
LD2	e'p	47,000
LHe	e'p	130,000
	e'pp	5,500
Cx4	e'p	161,000
	e'pp	5,600
Snx4	e'p	9,900
	e'pp	430
40Ca	e'p	67,000
	e'pp	3,600

Advantages of CLAS12 to CLAS6

- Cross Check with CLAS6
- High statistics for SRC data
- ${}^4\text{He}$, ${}^{12}\text{C}$, ${}^{40}\text{Ar}$, ${}^{40}\text{Ca}$, ${}^{48}\text{Ca}$, ${}^{120}\text{Sn}$ Targets
- Dedicated Neutron Detectors

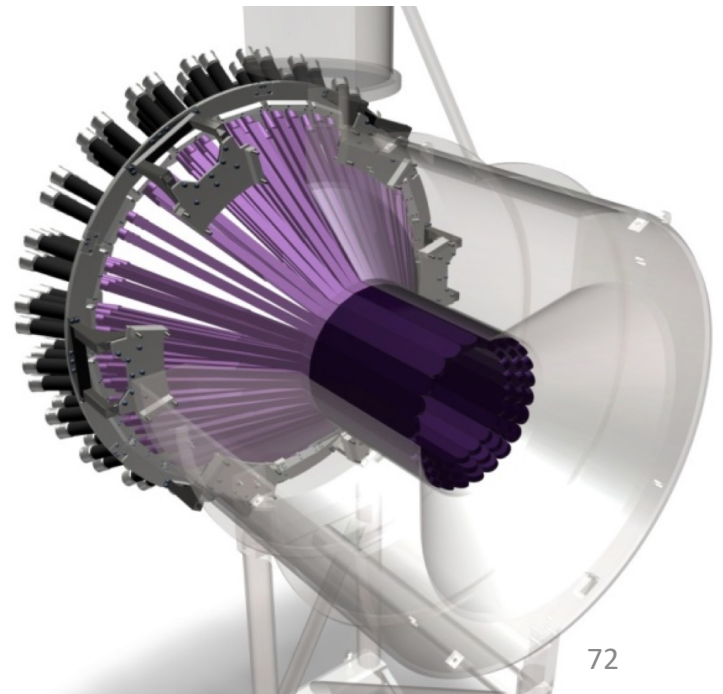

Advantages of CLAS12 to CLAS6

- Cross Check with CLAS6
- High statistics for SRC data
- ${}^4\text{He}$, ${}^{12}\text{C}$, ${}^{40}\text{Ar}$, ${}^{40}\text{Ca}$, ${}^{48}\text{Ca}$, ${}^{120}\text{Sn}$ Targets
- Dedicated Neutron Detectors
- Look at SRCs over a Range of Q^2

Components of the SRC

Pair Abundance

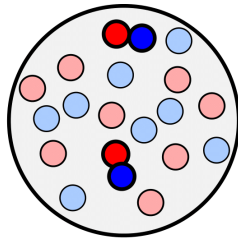

Center of Mass Motion

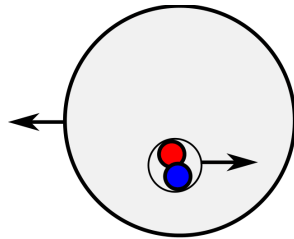

Pair Interaction

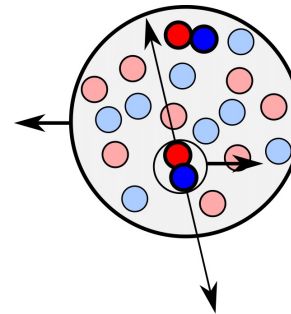
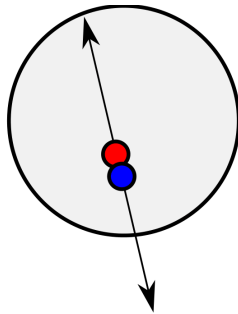

Factorized
Wave-Function

Center of Mass Motion

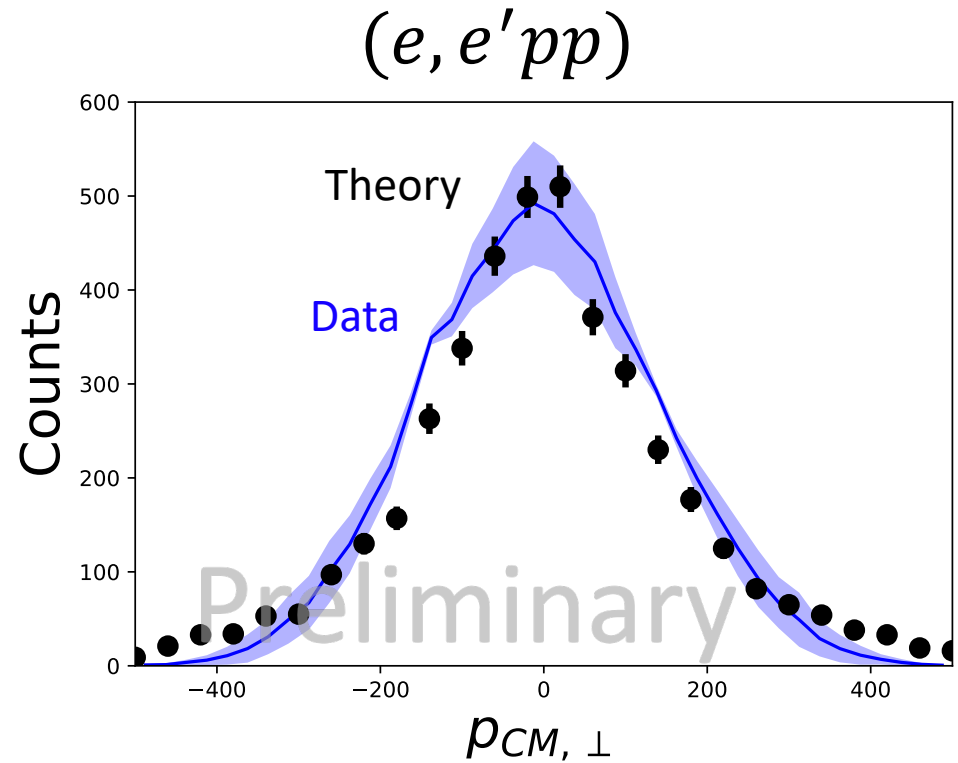
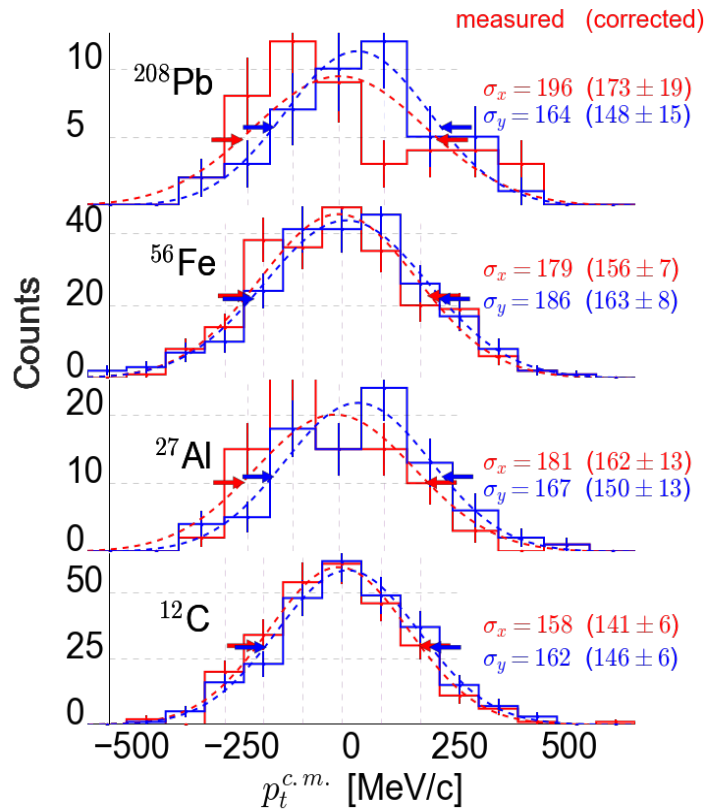
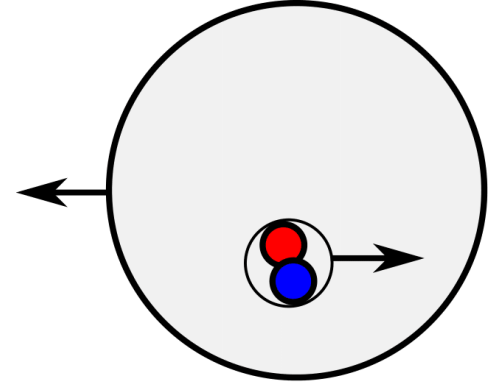

- Cohen, PRL (2018)

Pair Interaction

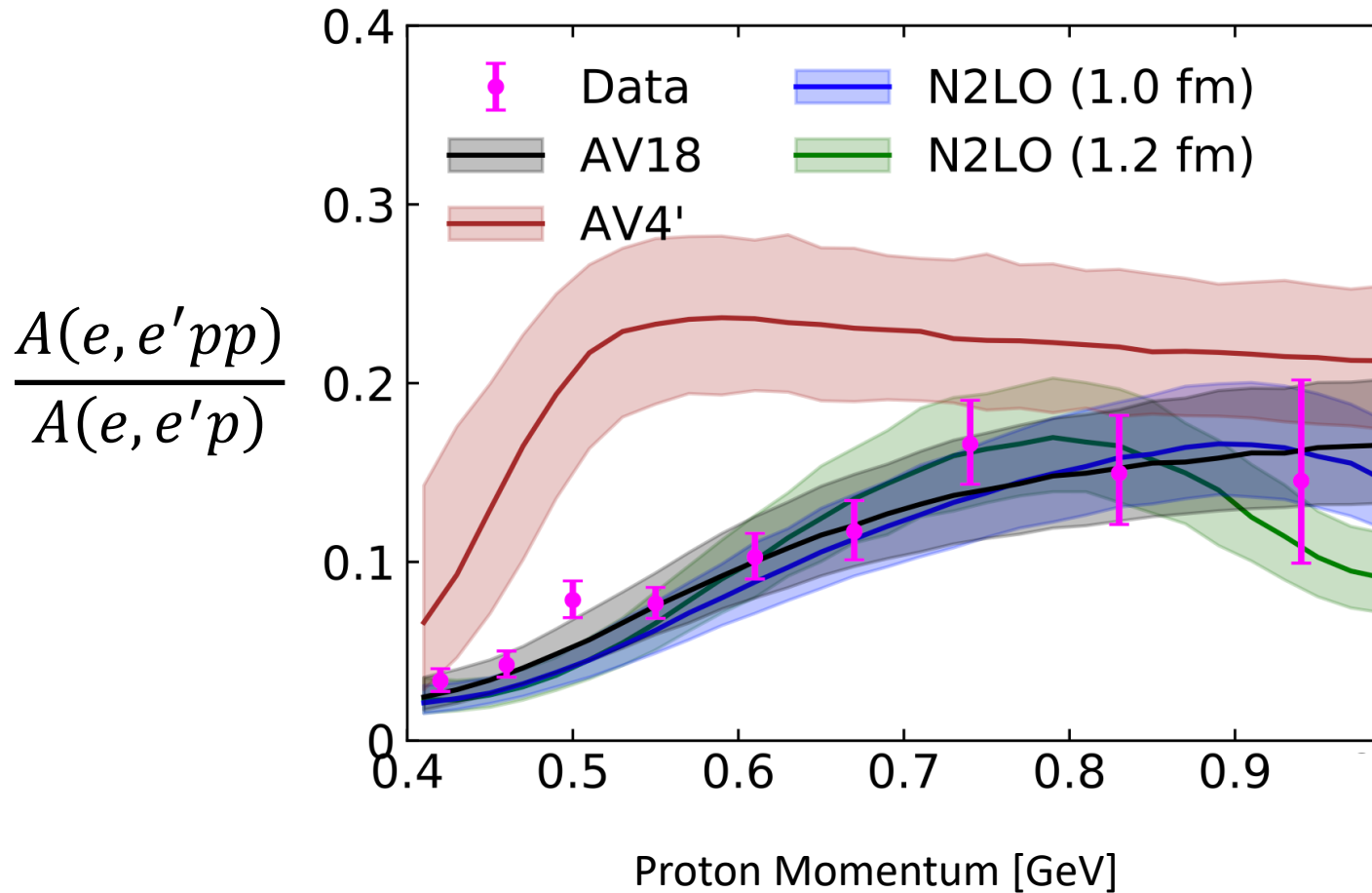
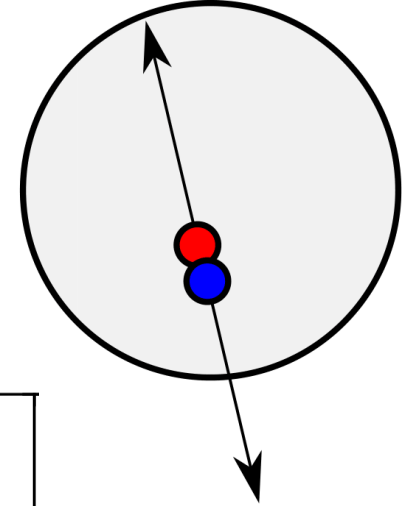

- Schmidt, Nature (2020)

Pair Interaction with CLAS12

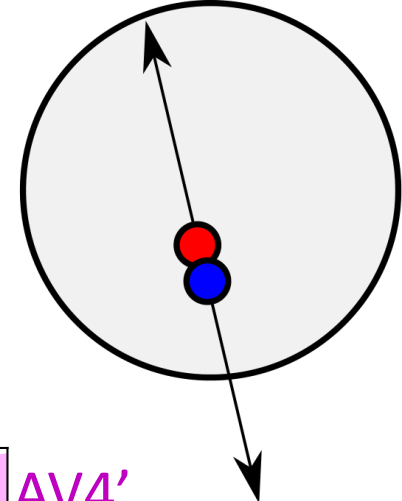

RGM Data

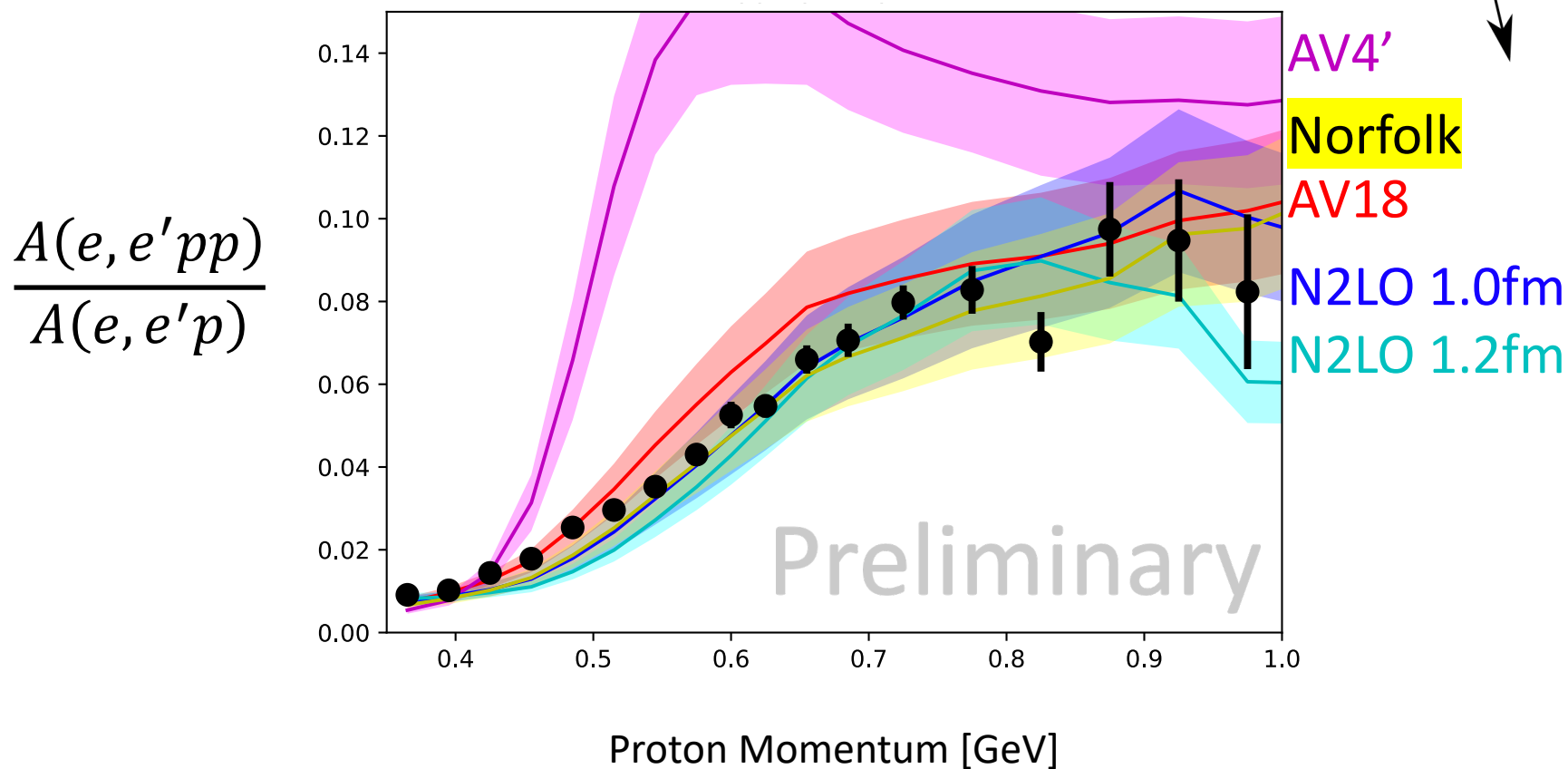

Pair Interaction with CLAS12

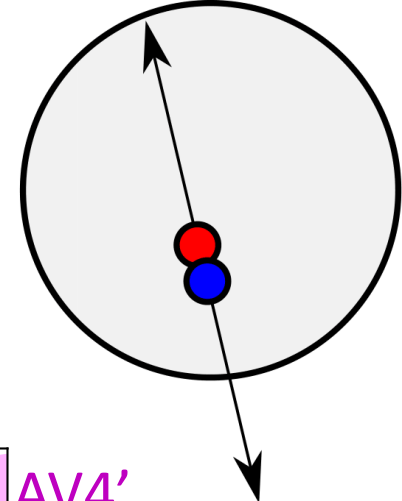

RGM Data

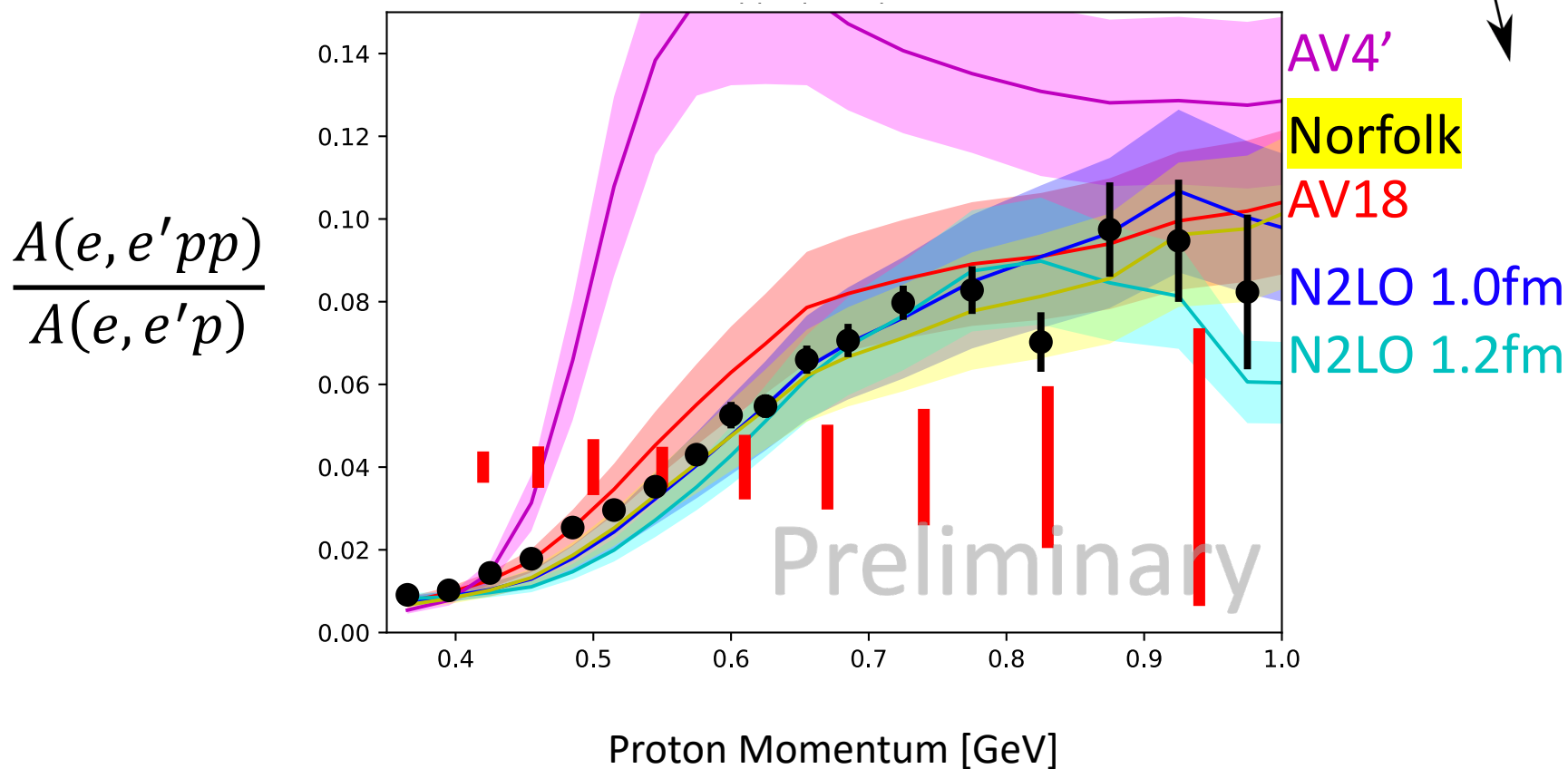

Components of the SRC

Pair Abundance

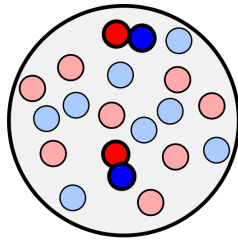

Center of Mass Motion

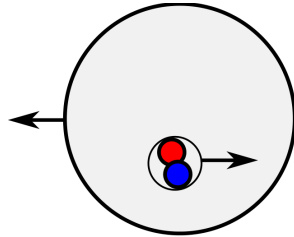

Pair Interaction

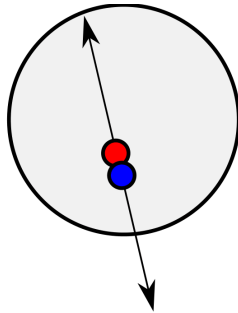

SRC Component of the Wave-Function

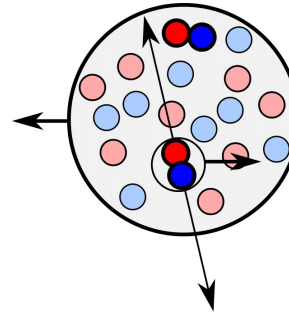

Components of the SRC

Pair Abundance

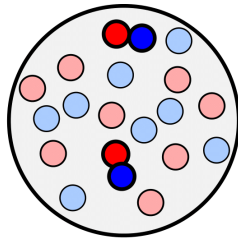

Center of Mass Motion

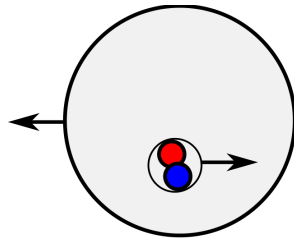

Pair Interaction

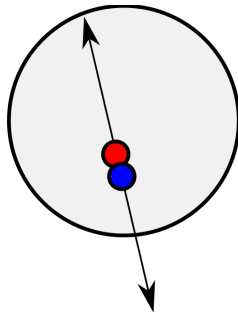

SRC Component of the Wave-Function

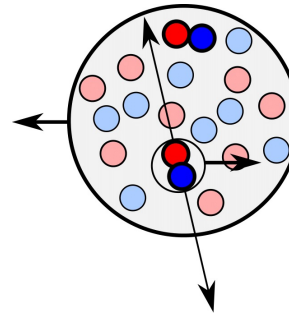

SRC Cross Section

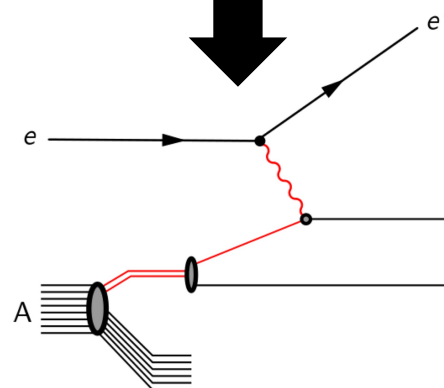

Components of the SRC

Pair Abundance

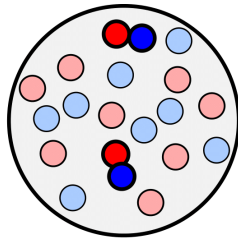

Center of Mass Motion

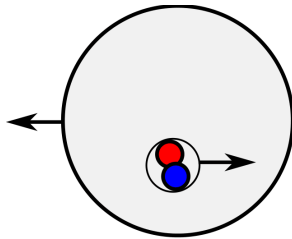

Pair Interaction

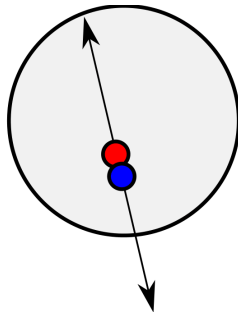

SRC Component of the Wave-Function

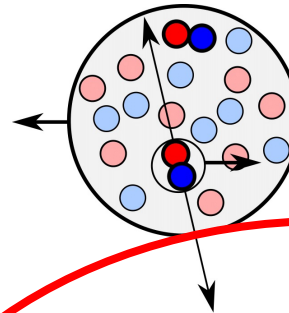

SRC Cross Section

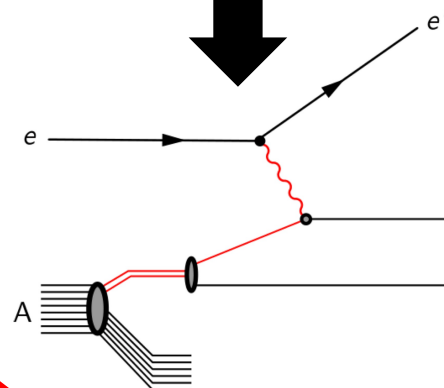

Scale Dependence of SRC Measurements

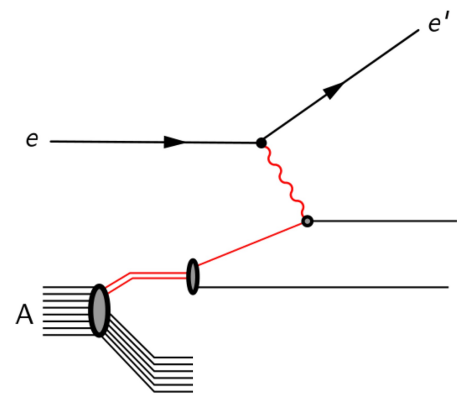

RGM Data

$$\frac{A(e, e'pp)}{A(e, e'p)}$$

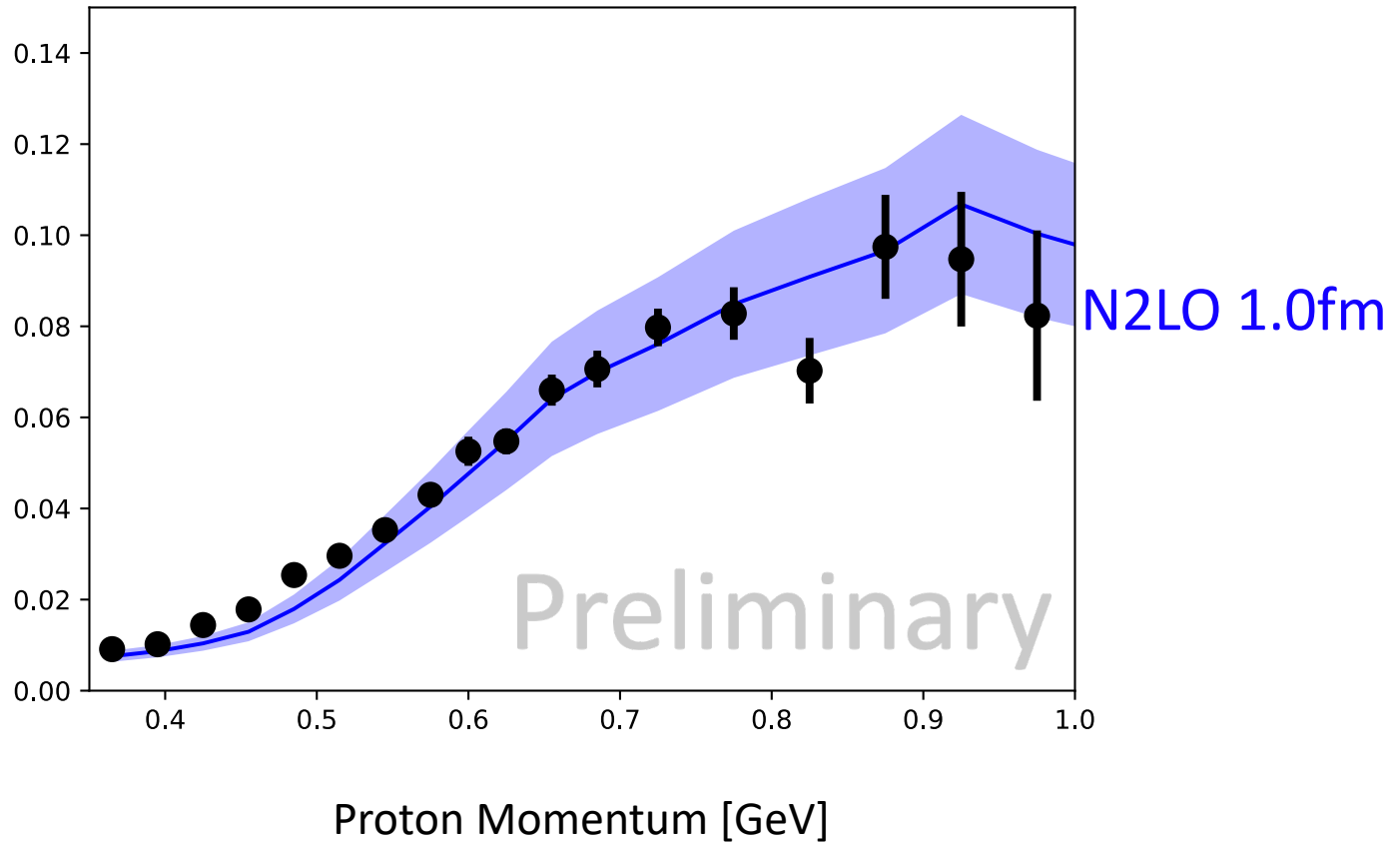

Scale Dependence of SRC Measurements

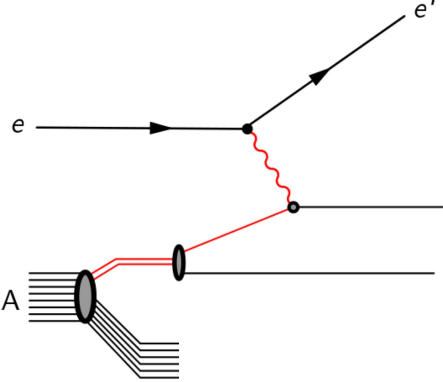

RGM Data

$$\frac{A(e, e'pp)}{A(e, e'p)}$$

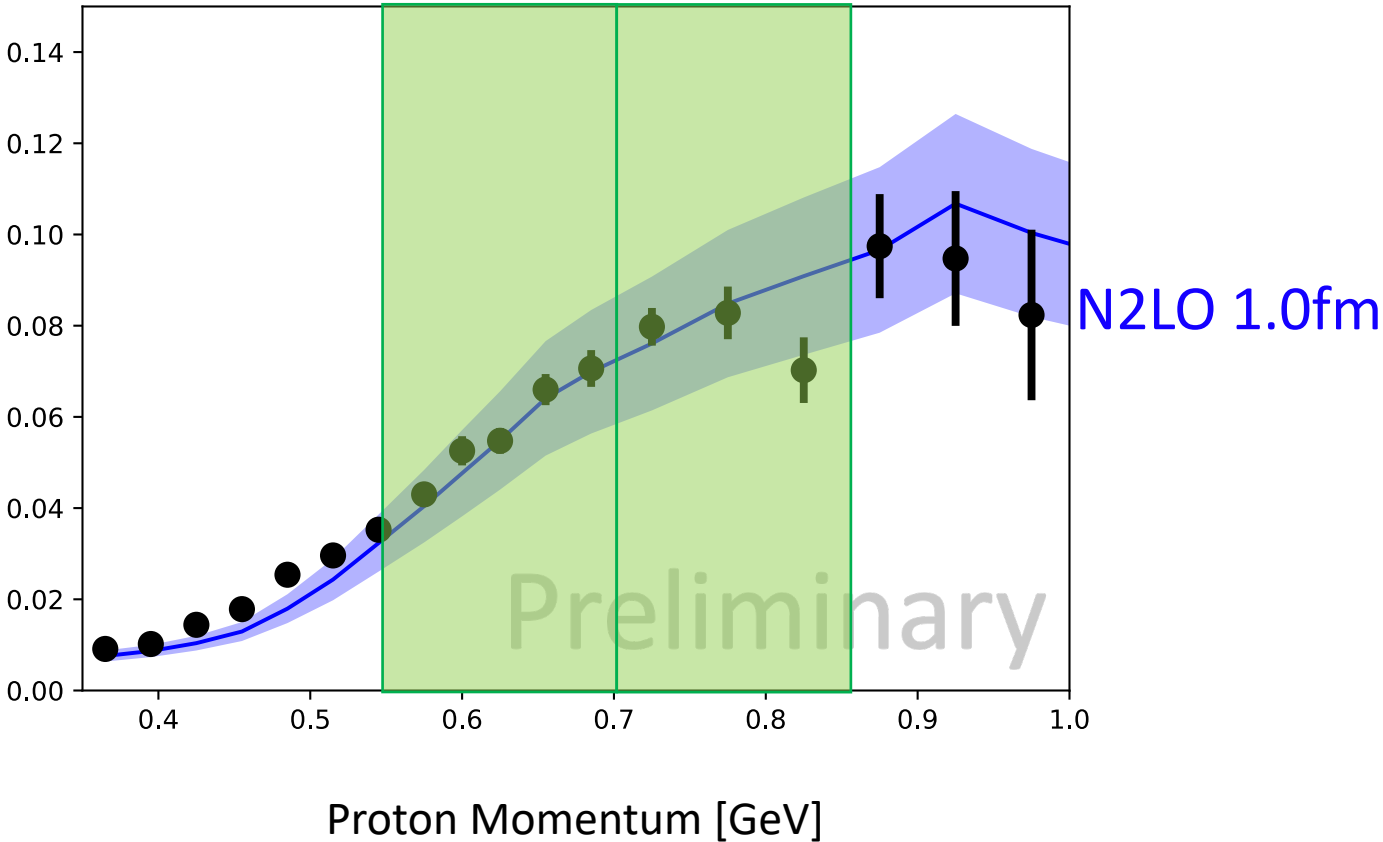

Scale Dependence of SRC Measurements

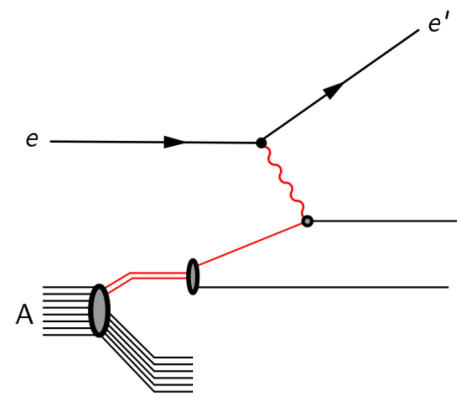

$$\frac{A(e, e'pp)}{A(e, e'p)}$$

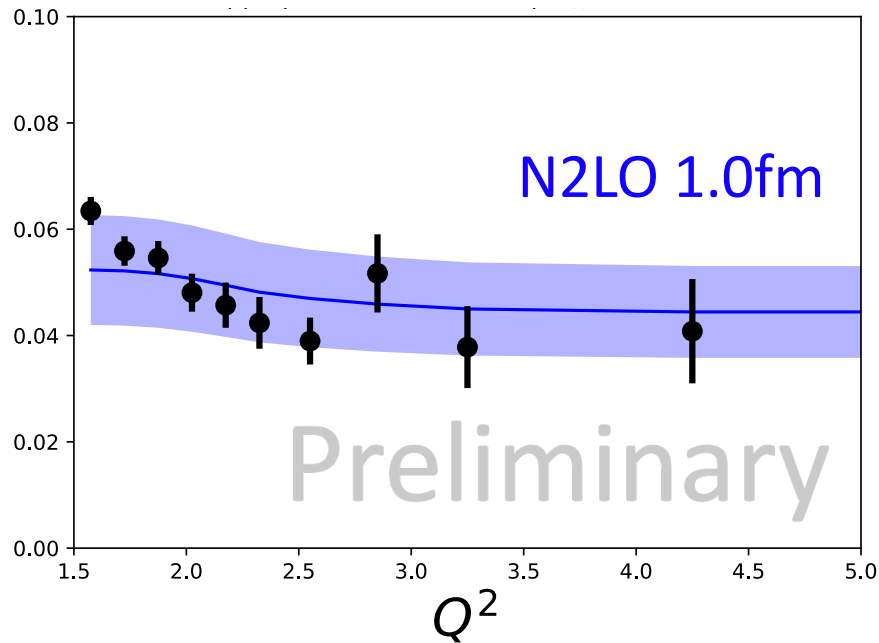

$$0.55 \text{ GeV} < p_{\text{miss}} < 0.7 \text{ GeV}$$

$$\frac{A(e, e'pp)}{A(e, e'p)}$$

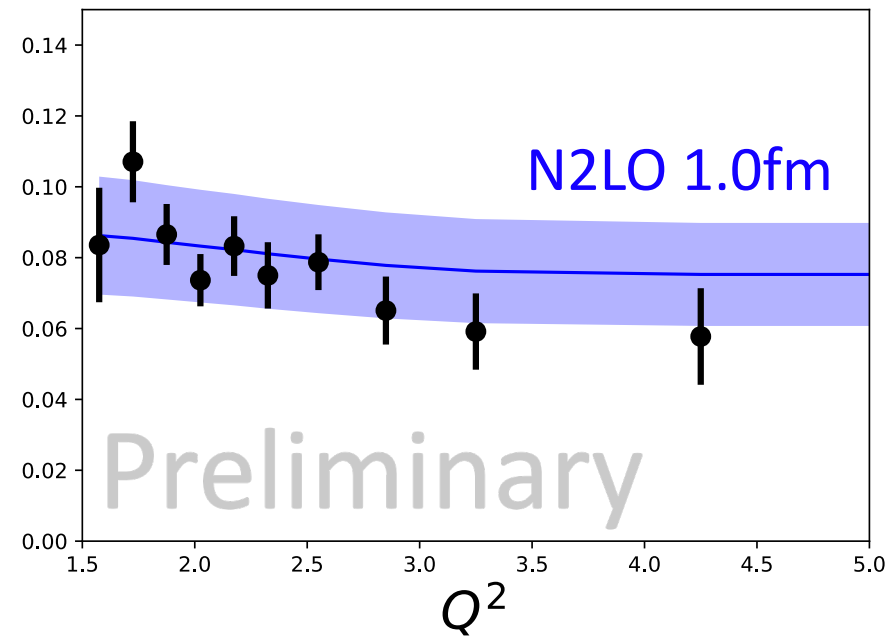

$$0.7 \text{ GeV} < p_{\text{miss}} < 0.85 \text{ GeV}$$

Scale Dependence of SRC Measurements

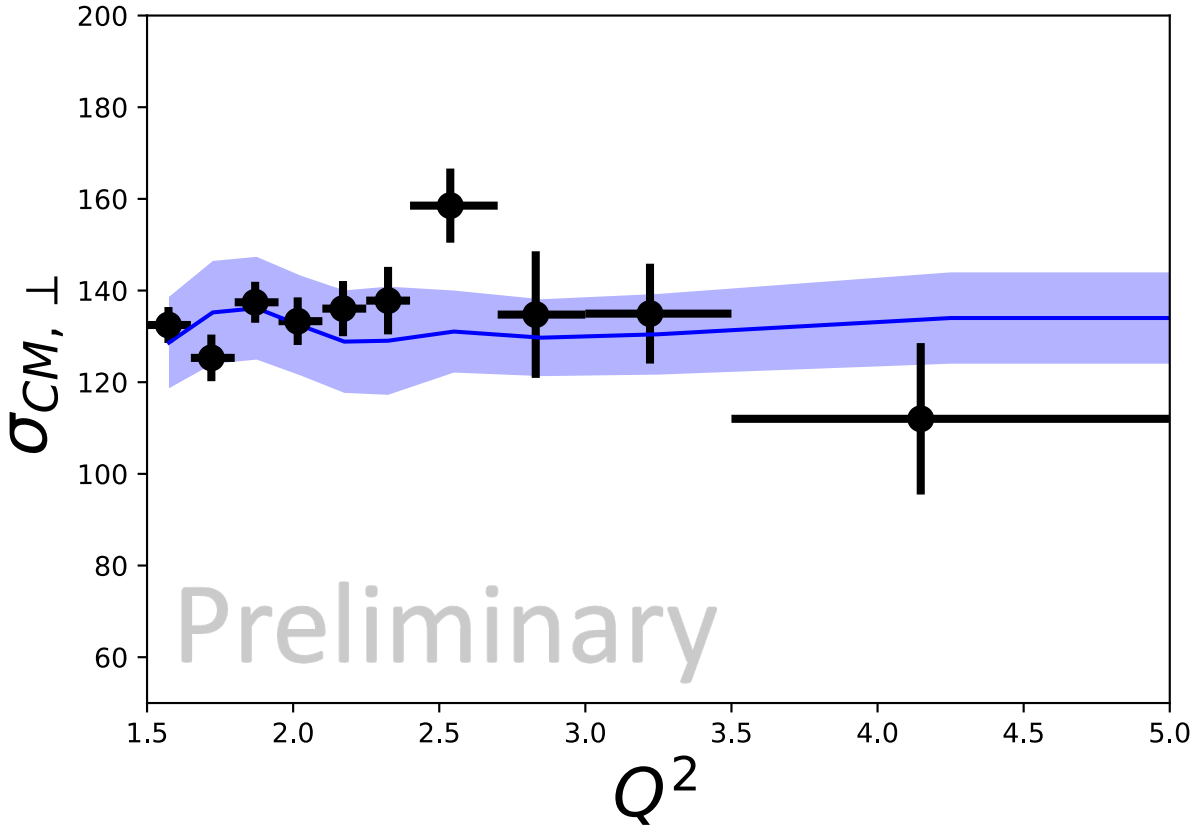
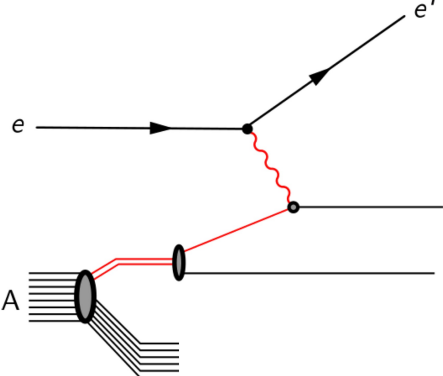

Overview of Exclusive SRC Measurements

- First Exclusive Measurements

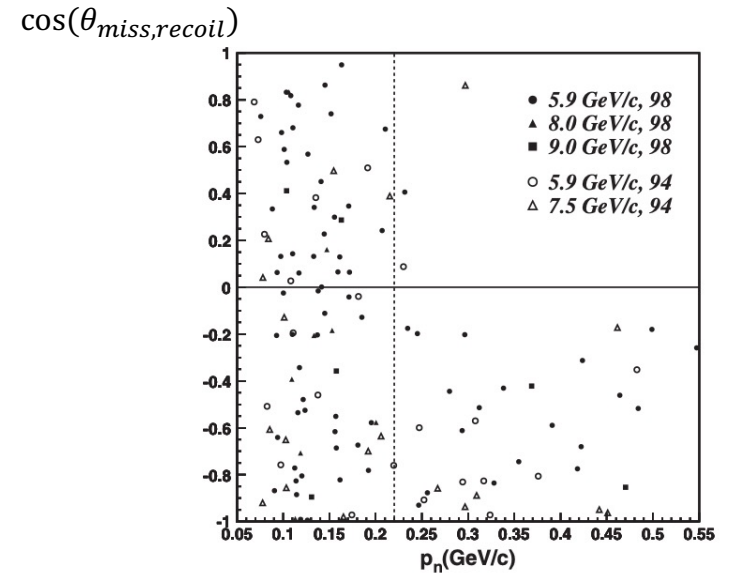

Overview of Exclusive SRC Measurements

- First Exclusive Measurements
- CLAS6: The Perfect Detector for SRCs

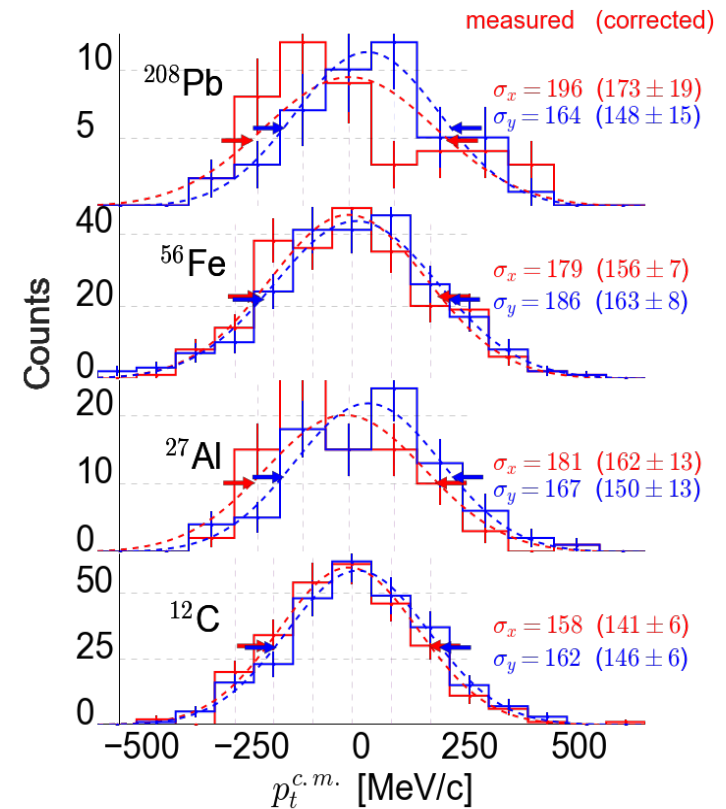
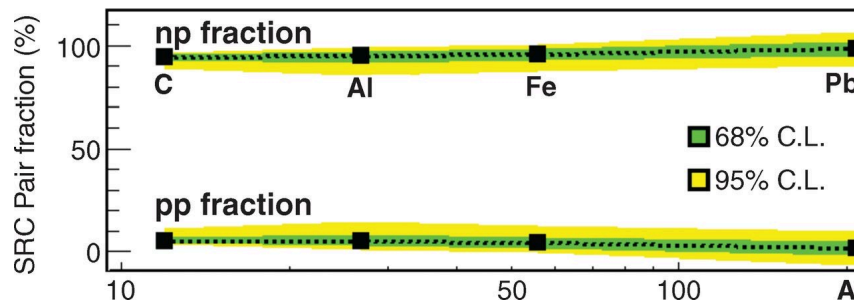

Overview of Exclusive SRC Measurements

- First Exclusive Measurements
- CLAS6: The Perfect Detector for SRCs
- Generalized Contact Formalism

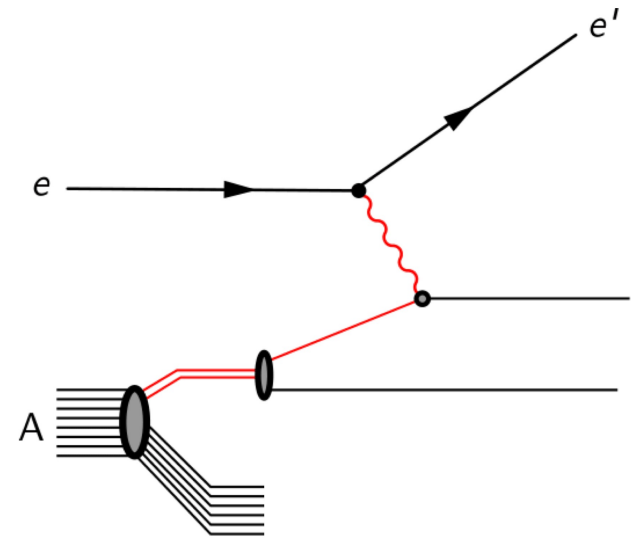

Overview of Exclusive SRC Measurements

- First Exclusive Measurements
- CLAS6: The Perfect Detector for SRCs
- Generalized Contact Formalism
- SRC Universality

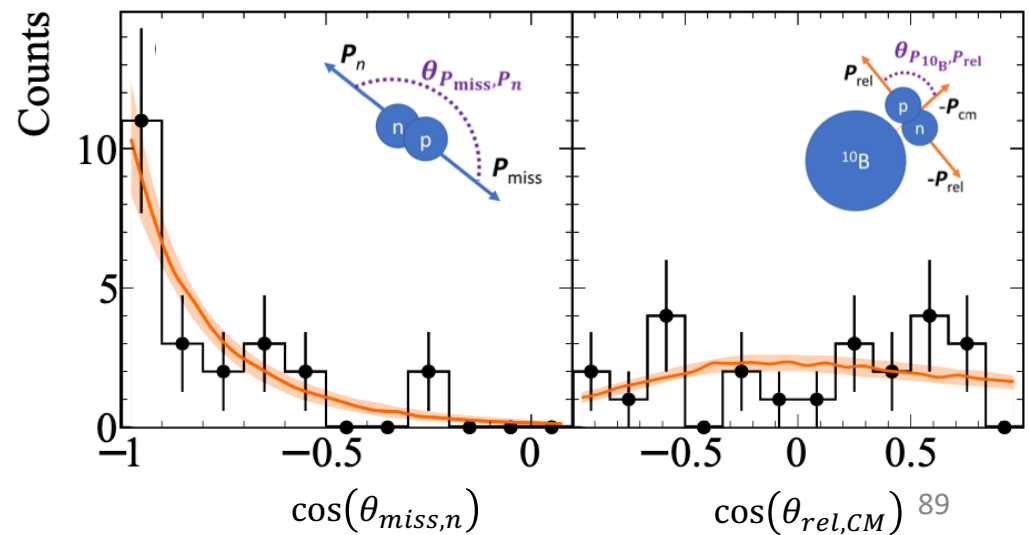

Overview of Exclusive SRC Measurements

- First Exclusive Measurements
- CLAS6: The Perfect Detector for SRCs
- Generalized Contact Formalism
- SRC Universality
- SRCs with CLAS12

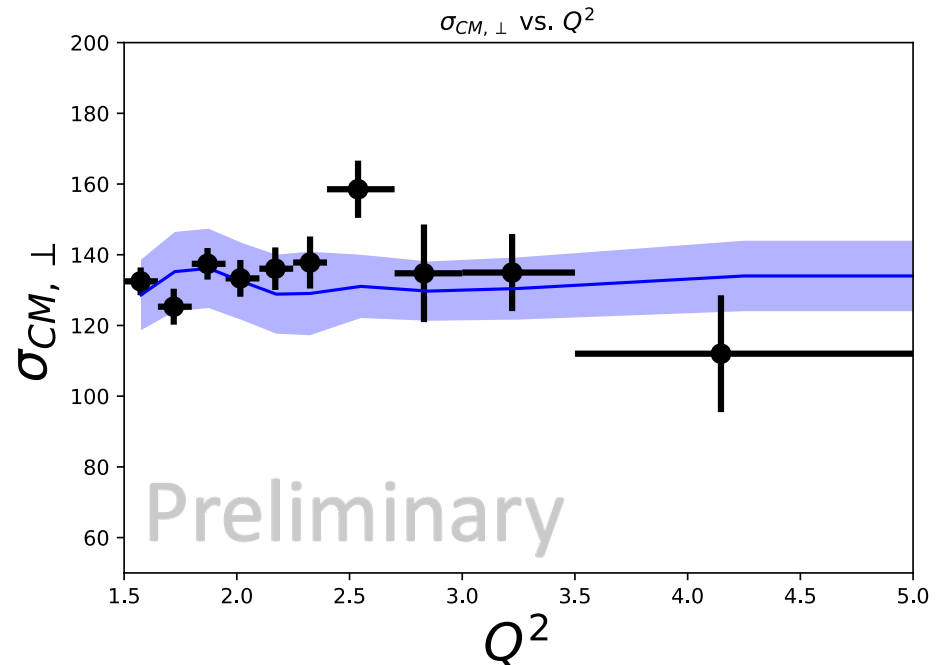

End

Inclusive Measurements

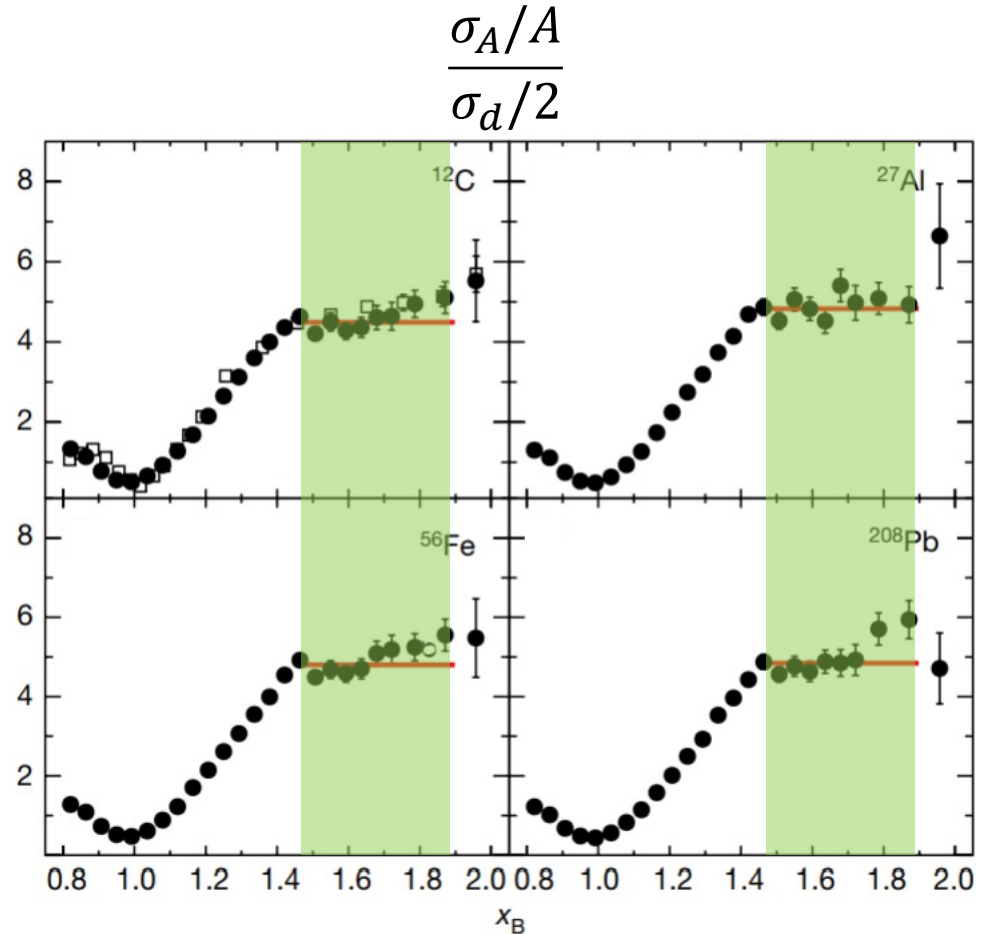
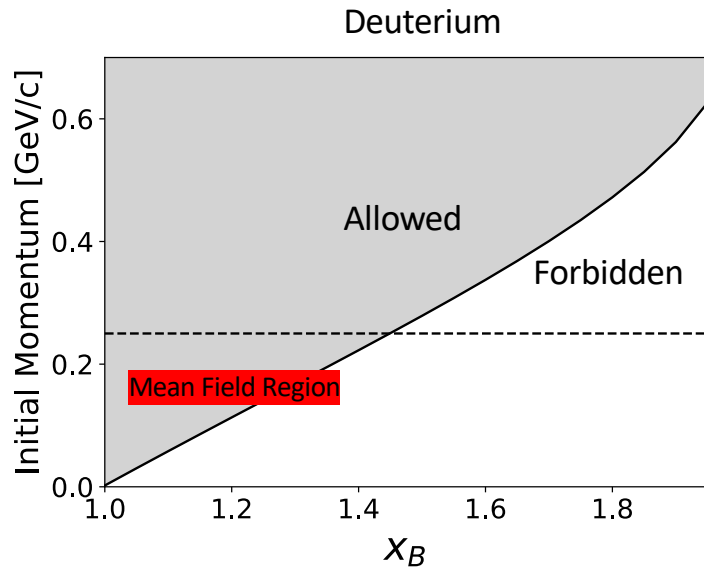

- Schmookler, Nature (2019)

$$x_B \equiv \frac{Q^2}{2m_N\omega} = \frac{q^2 - \omega^2}{2m_N\omega}$$

What do we know?

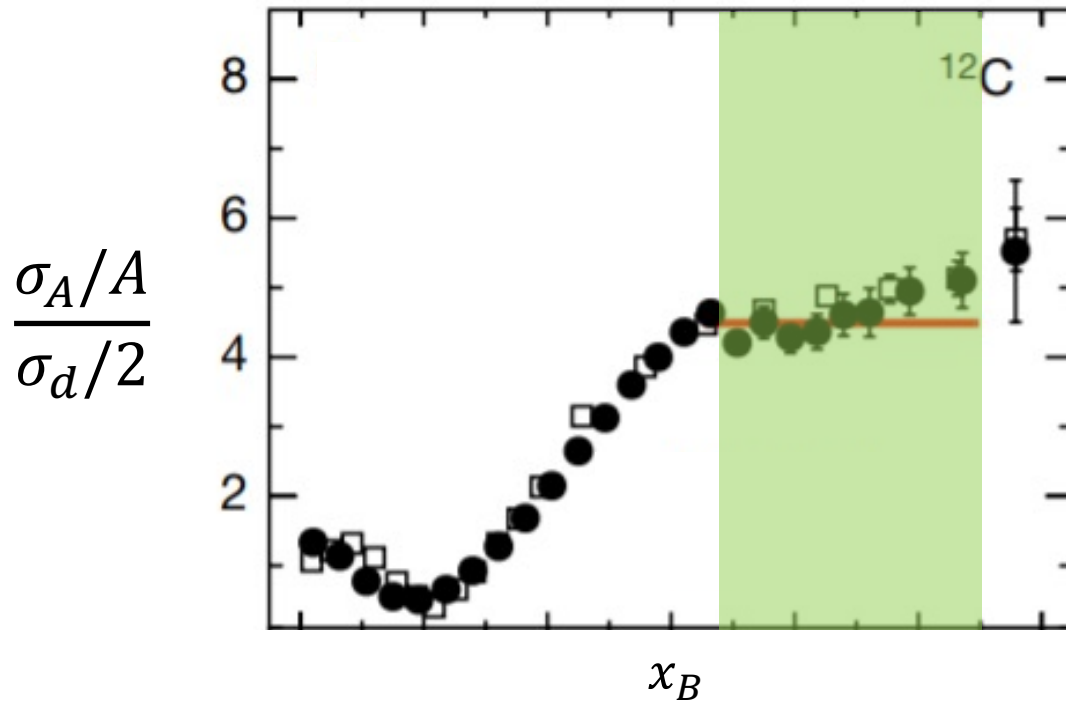

$$x_B \equiv \frac{Q^2}{2m_N\omega}$$